

2022-2023



B&G

LIEBERMAN

2420 Distribution Street
Charlotte, North Carolina 28203
704.376.0717

Toll Free 1.800.438.0346
Fax 1.800.248.2696
Email bgl@bglieberman.com
www.bglieberman.com





Our Founder
Jerry Lieberman
1924-2011



71 Years
Marianne Lieberman



68 Years
Walter Marx

In Memoriam
with gratitude for many
years of service
to our company



44 Years
Billy Lynette
Passed in 2017



39 Years
Roger Grandy
Passed in 2016



39 Years
Eric Byers

B&G LIEBERMAN CO., INC.

Here is our dedicated staff!



20 Years
David Barlow



42 Years
Peter Marx



32 Years
Ed Babbitt



69 Years
Lee Marx



34 Years
Robert Marx



37 Years
Kyle Rakocy



19 Years
Denise Taylor



13 Years
Tonda Galant



43 Years
Larry Lieberman



30 Years
Tammi Schwerdt



18 Years
Amy Edwards



12 Years
Aprille Farnsworth



7 Years
Jenny Tran



30 Years
Charles Neu



32 Years
Bill Stevens



9 Years
Cathy Allen



7 Years
Wanda King

LOCKSTITCH SEWING MACHINES

You are guaranteed quality and value when you choose a **LIEBERSEW™** brand machine. We import from only top factories of each type of machine, and we check each machine

Prices include stand, servo motor and light.

LIEBERSEW™ 8700

HIGH SPEED STRAIGHT STITCH MACHINE

Straight Stitch
Auto Lubrication
Dropfeed LOCKSTITCH.
Reverse Feed 5500rpm
Horizontal Hook
0.5mmstitch length
13mm footlift
Needle 16 x 231
Made in China

Head Only **\$425.00** Complete **\$699.00**



LIEBERSEW™ LOCKSTITCH 8000B Direct Drive



**Built in Direct Drive
Motor with Table
and Light**

Direct drive motor
includes needle
stop up or
down option.
Needle 16 x 231
\$725.00



LIEBERSEW™ LS9000

**Automatic Lockstitch
Direct Drive Sewing
Machine with Backtack, Footlift &
Thread Trim**
Needle 16 x 231

High Speed Lockstitch machine, built in servo motor, computerized control panel, automatic direct drive trimming, automatic foot lift, programmable backtacking.

Complete **\$1,095.00**



JUKI SEWING MACHINES

You are guaranteed quality and value when you choose a **LIEBERSEW™** brand machine. We import from only top factories of each type of machine, and we check each machine

Prices include stand, servo motor and light.

JUKI DDL-8700

The industry's proven workhorse.
Single needle lockstitch with reverse.
Self-oiler with reservoir.
Popular for alteration and tailoring.
Made in China / Vietnam
Needle 16 x 231



Head Only **\$579.00** Complete **\$849.00**

(Full Juki Line Available)

JUKI DDL-5550

Juki DDL5550N Sewing Machine & Table come mounted on a the table with our motor. This Juki sewing machine has low vibration and low noise, the machine head provides the operator with a comfortable work environment. In addition the distance from the machine arm to the needle on the front of the machine head is sufficiently wide to allow easy handling of the sewing material. This machine has high speed stitching performance 5,500 rpm ease of operation, and is very reliable. Great to use on medium weight fabrics. Features include Stitch length of 5mm, presser foot lift, needles bobbin, servo motor and newest LED light included. 60 day warranty from date of purchase The only lockstitch still made in Japan.



Head Only **\$649.00** Complete **\$949.00**

Needle 16 x 231

JUKI DDL-8000A

Energy-saving servomotor is installed in the direct-drive style. The energy-saving and highly efficient servomotor is installed in the direct-drive style to transmit power without loss to the sewing machine, thereby providing improved responsiveness, quicker start-up and increased needle penetration force. The compact-sized control box and operation panel Both the compact-sized control box and the operation panel are integrated with the machine head. The machine is provided as standard with the operation panel.



Needle 16 x 231

Complete **\$1,695.00**

**Direct-drive, 1-needle,
Lockstitch Machine with
Automatic Thread Trimmer**

WALKINGFOOT SEWING MACHINES

Machine Heads only or complete with stand and motor.
Prices include stand, servo motor and light.

LIEBERSEW™ - 1541S WALKING FOOT MACHINE

Finally an affordable leather machine! Fits in a standard cutout table. It is a top and bottom feeding system with alternating pressure foot lift for sewing leather, synthetic leather, canvas etc. An automatic lubricating system reduces abrasion of the drive system. A large hook accommodates a large bobbin. Zipper feet, cording and welting feet are available options. Adjustable presser feet height dial. Single Needle Lockstitch, Unison Feed Machine with New Safety Clutch Mechanism. Stitch length up to 8mm, adjustable. Extra high foot lifts up to 16mm. Large double capacity bobbin. Horizontal axis hook makes it possible to change bobbin without removing work. Automatic hook lubrication. Easy to operate Needle DPX17 18-24.



Head Only **\$1,295.00**

Complete **\$1,595.00**

CONSEW 206RB

Excellent WALKING FOOT machine for sewing leathers and canvas. Also good for heavy blue jeans. Compoundfeed moves material along. We have sold hundreds of these for Cleaning Plants, Western stores and Upholstery Shops. Needle DPX17



Full Consew Line Available

Head Only **\$1,495.00**

Complete **\$1,795.00**

LIEBERSEW™ 341 Cylinder Bed Walking Foot Sewing Machine



Comes complete with edge guide, table and servo motor. Optional binder attachment and flat surface option available
Binder Attachment \$100.00 Flat Surface \$100.00 \$1,395.00

JUKI DNU-1541S

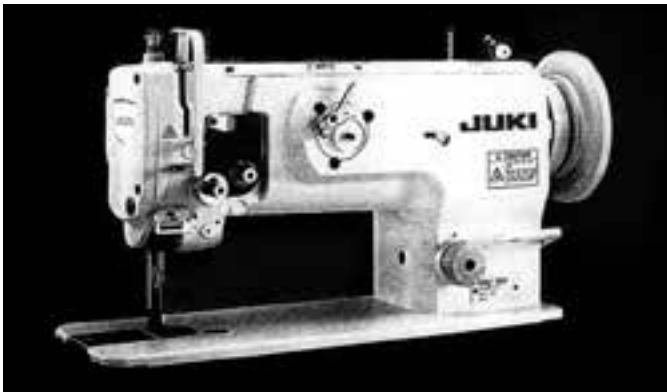

Single Needle Lockstitch, Unison Feed Machine with New Safety Clutch Mechanism. Stitch length up to 8mm, adjustable. Extra high foot lifts up to 16mm. Large double capacity bobbin. Horizontal axis hook makes it possible to change bobbin without removing work. Automatic hook lubrication. Easy to operate. Needle DPX17

Head Only **\$1,695.00**

Complete **\$1,995.00**

LIEBERSEW™ 441 Cylinder Bed Heavy Duty Walking Foot Sewing Machine

Comes complete with edge guide, table and servo motor.

Optional binder attachment and flat surface option available

\$1,695.00



ZIG ZAG & STRAIGHT STITCH, MULTI-STITCH & BUTTONHOLE SEWING MACHINES

You are guaranteed quality and value when you choose a **LIEBERSEW™** brand machine. We import from only top factories of each type of machine, and we check each machine

Prices include stand, servo motor and light.

LIEBERSEW™ 199R **LIEBERSEW™ ZIG-ZAG & STRAIGHT** **STITCH SEWING MACHINE**

Our exact copy of the original Consew.
Both are now made in China.
Standard bed size

Rotary hook.
Needle 135x5

Head Only **\$1,995.00**
Complete **\$2,395.00**



LIEBERSEW™ LS-20U93D **DIRECT DRIVE with Table** **LIEBERSEW™ ZIG-ZAG & STRAIGHT** **STITCH SEWING MACHINE**

Our exact copy of the original SINGER.
Built on main shaft - no belt
Bed size 15 1/2 x 7
3 needle positions.

Rotary hook.
Needle 135x5

Head Only **\$745.00**
Complete **\$895.00**



JUKI® HZL-80 A **MULTI-STITCH**



\$525.00



20 PATTERN SELECTIONS

Needle Threader LED Light

Needle: HAX1(130/705H) #9-#16

LIEBERSEW™ BG9820-01 **BUTTONHOLE MACHINE**



Lorem ipsum
The most versatile automatic programmable buttonhole machine on the market. Computer panel stores all the different types of buttonhole patterns in the memory that you can choose to load. Keyhole with tack at end with or without cut. Can run on 220v or 110v with transformer. Requires compressed air. Automatic thread trimming is also a new feature. Needle: DOX558

This machine replaces the Suzuki ECLS SE-200.

Extensive Manual and Parts Book Included. \$10,995.00

SERGERs AND BUTTON SEWERS

LIEBERSEW™ -737

High quality industrial serger.

Available in 3, 4 or 5 thread, high speed.

Made in Taiwan.

Our mechanics think highly of this machine.

SUPER VALUE!
Needle DC X1

Complete with table and motor.



Prices include stand and motor.

737 **\$1,095.00** 3 thread
747 **\$1,195.00** 4 thread
757 **\$1,295.00** 5 thread

JUKI - MO 6800 SERIES

High quality industrial serger. Available in 3 thread #6704, 4 thread # 6714, 5 thread, # 6716, high speed, top of the line. Self oiling, adjustable stitch length. Needle DC x 1



6804 \$1,695.00 3 thread
6814 \$1,795.00 4 thread
6816 \$1,795.00 5 thread

Complete with table and motor.

For Head Only Prices, Please Call

JUKI-LOCK PORTABLE SERGERS

Available for all models. Built-in roll hem feature easy lay in thread guides and stitch bight adjustment.

Built in light and thread cutter and safety finger guard.

Needle (15 x 1)

All other Juki models available as well.

Industrial type table available for submerged setup.

\$199.00



MO623 3 thread **\$319.00**



MO644D 3/4 thread
\$355.00
with differential feed

JUKI - MB 1373 BUTTON SEWER

1373 w/knife thread trimmer.

Industrial, Electric High Speed Button Sewer.

Great for Shirt Laundries for button replacement and for Alteration Departments to resew sleeve buttons. Can be converted to a cuff tacker. Needle 175 x 1 **\$3,695.00**



JUKI MULTISTITCH 1377

with cross & parallel stitch option

Sit-down or stand-up table available.
\$3,895.00 Complete



LIEBERSEW™ - 1377 ELECTRIC DIRECT DRIVE BUTTON SEWER



Cross-stitch and parallel stitch **BUTTONSEWER** is the best machine we have ever sold.

You can match the factory stitch of the button now with a flick of the lever. And we set it up to sew from a 14L to a 30L with no adjustment needed. Every machine is sewn off and warranted for a year.



\$1,395.00 Head Only
\$1,495.00 Complete with tall stand or sit down table.



LIEBERSEW™ 1377

Hand Crank Button Sewer
 Includes cross stitch or parallel
 stitch changing option.

\$1,395.00 Complete with stand
\$1,295.00 Head Only

LIEBERSEW™
1377 Button Sewer
Tall Type Stand or
sit down available.
 5 Tilt Bins Optional **\$229.00**

ASCOLITE®

World leader in button securing.



\$2,995.00

Ascolite® is the unique button security system worldwide since 1972. The Ascolite® system consists of the highly elastic and heat-sealable. Ascolite® TF-yarn and the Ascolite® BSS wrapping machines, developed in Switzerland specially for button-shank wrapping.



ASCOLITE® TF-YARN, SWISS MADE

Ascolite® TF (thermofusion) yarn is specially designed for button-shank wrapping with securing effect. It's unique elastomeric gripping force and the heat sealing are the keys to button loss prevention as our yard permanently squeezes the attaching thread and holds them fast.



We stock:
 Black
 White
 Navy
 Grey
 Dk. Brown
\$26.95

Ergonomic Sewing Chair

LASTING...ENDURING

A true ergonomic industrial chair that comes standard with pneumatic height adjustmet. fully adjustable back, 360 degree swivel, and a five leg base, contoured seat for added comfort and fingertip levers for easy adjustments.

Wide seat, black.

\$188.00



\$49.95
 box of 4,000
 1/2" x 1/2"

BUTTON BACKERS
 for
 Buttdown Shirts.
 Little iron-on reinforcements.
 4000 to the box,
 white only.

LIEBERSEW™ BLINDSTITCH MACHINES, COVERSTITCH MACHINES

We fine tune and sew off each machine for your specified application to assure perfect sewing upon its arrival at your door.

Our stand and motor is shipped on a skid of our own design to ensure that it arrives undamaged.

All Blindstitch machines come with deluxe "K" legs, Formica tops, deluxe sewlights and self-contained clutch motors. For details, including information on machines not shown here, please ask our representative or write for descriptive literature.

LIEBERSEW™ CM-101

High Quality Blindstitch, based on Lewis 150 design, w/skip stitch, excellent on light to medium fabrics. Easy adjustment of stitch length, tension and depth. Includes full size swing arm.



Complete **\$1,195.00** Head Only **\$795.00**

Needle 29x49 / LWX6T

U.S. STITCHLINE SL 718-2

Built to the same specs as original U.S. Blindstitch machine, for slacks, trousers, skirts, dresses, coats, draperies, curtains, blankets and bedspreads. With 2-to-1 or 1-to-1 stitch ratio. Perfect for department stores, tailors and dry cleaners. Top of the line.



Complete with stand and motor

\$1,795.00

Needle size: 251 LG / LW X 5T Head Only **\$1,595.00**

LIEBERSEW™ LS562 COVERSTITCH

Industrial Flatbed Coverstitch Machine can be set up with 2 needle or 3 needle Topstitch with bottom cover or top and bottom cover.

Needle: UY128GAS

Complete **\$1,195.00**

Head Only **\$895.00**



LIEBERSEW™ CM-500 PORTABLE BLINDSTITCH

We test each machine before shipping. It sews fine and medium weight fabrics. The skip stitch feature works well for extra fine fabrics.

- Swing away bedplate supports garment.
- Side mounted thread tensions.
- Skip stitch feature for 1-1 and 2-1 stitching.
- Stitch length 3-7 mil. 1,200 max. stitches per minute.
- Ideal for Department Stores, Alteration rooms, Tailors, Dry Cleaners, Dress Makers, Clothing rentals or Home Use.



Needle Size 29 x 49 / LW X 6T

An excellent value compared to other machines at double the price.

\$299.00

NEW

MCS 1500 JUKI PORTABLE COVERSTITCH

Professional quality sewing of wide and narrow 4 thread or 3 thread coverstitch hem and also single needle chain stitch. Easy threading of looper with built-in edge guide on the presser foot.

Needle Size 130 /705H
11", 14"

Optional Hemmer guide available.

\$639.00



LIEBERSEW™ LS-664 CYLINDER ARM COVERSTITCH MACHINE

Complete on semi-submerged table with SERVO MOTOR
For knit fabrics. Eases hemming pants & sleeves
2 or 3 needles for 3mm or 6mm with parallel stitching.



**\$1,475.00
COMPLETE**

**\$1,195.00
HEAD ONLY**

SEWING MACHINE PARTS & ACCESSORIES

Call for parts not shown.

Complete Superior parts line available.

Piping Feet



REGULAR HINGED
\$5.95

#24983



SPLIT HINGE ZIPPER
\$5.95

#40322SH



RIGHT HINGED CORDING ZIPPER
\$5.95

#12435HN



LEFT HINGED CORDING ZIPPER
\$5.95

#31358HN



Double Turn BALL HEMMER FOOT

SPECIFY SIZE
BALL GAUGE SIZE
490358 1/16"
490358 1/8"
490358 3/16"
490358 1/4"



\$10.95



LEFT

\$7.25



RIGHT

#36069L 1/8 Left Gauge Size 1/8"
#36069L 1/4 Left Gauge Size 1/4"
#36069R 1/8 Right Gauge Size 1/8"
#36069R 1/4 Right Gauge Size 1/4"

PRESSER FOOT
140390 Screw \$0.95

#286 Medium Thumb Screw \$1.25

SOLID TEFLON MOLDED FEET FOR SINGLE NEEDLE LOCKSTITCH



\$19.95



\$11.95



\$11.95

THREAD CUTTER

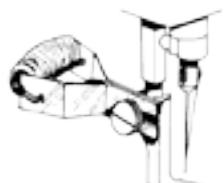

#GS1 EASILY ATTACHED TO FOOT BAR \$6.50

INVISIBLE ZIPPER FOOT HINGED



LONG SLOTS #S518 \$10.95

GATHERING SHIRRING FOOT 120828



\$6.50

DOUBLE FOLD SCROLL HEMMING FOOT



120803 1/8" \$15.95
120806 1/4" \$14.95

JUKI M0623 SERGER PARTS

Two Thread Conversion Kit

Instructions Included

\$14.25



Upper Loper
A2512-234-000
\$23.95



Lower Loper
A2526-335-00S
\$29.95



Upper Knife
A41412-35-000
\$7.25



Lower Knife
A4142335000
\$7.25



SINGLE NEEDLE LOCKSTITCH MACHINES

PLATE & FEED DOG



Plate \$4.75

MEDIUM NEEDLE HOLE
#147150Lg (Line gauge)
#147150LgT Teflon Coated \$20.95



\$4.35

#149057
#147057T Teflon Coated Guard \$10.95



for LIEBERSEW LS-8700
From yr. 2013
Needle Plate 145971-0-01 (1109012A)

Feed dog \$7.25
100334-0-01 \$6.45

PLEASE SPECIFY NAME AND MODEL #



\$76.95

#143342FG FULL GIB HOOK



#52237 \$5.95 BOBBIN CASE



doz. \$7.20 BOBBIN #55623

TENSION COMPLETE For Singer

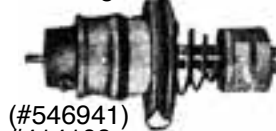

(#546941) #414109 \$23.95 #414274

For Singer Classes 591C, 591D

TENSION COMPLETE for JUKI type Machines



\$23.95

FOR SINGER 20U ZIG-ZAG

#541936 PLATE Zig Zag

#541678 BOBBIN CASE

#541674 HOOK \$82.50

#541647 FEED DOG Zig Zag



\$9.95



#55623 BOBBIN \$6.50

For straight stitch conversion use, Plate 541937, Feed Dog 541734.

EYE GUARD

PROTECTS OPERATOR FROM BROKEN NEEDLES
Individually packed
Easily attached with 2 screws
FOR SINGER 175; 69; 71; 99W 114 CLASS
also for Union Button sewers and Reece buttonholder.



#EG104 HI IMPACT TRANSPARENT PLASTIC \$15.95

FINGER GUARD \$5.25



#19S (#61231A) For Single Needle SINGER Machines

SINGER 31-15, 331K

SA- TENSION COMPLETE



\$33.50



\$17.75 #12393 Hook



\$15.75 44118 (106C) (31, 44CL)

#24415 (#107741) Race Complete (31-15; 331K)

#24419 (#107743) Race Complete (331K except 331K1)



#2996 doz. \$7.25



#62740 BOBBIN CASE ea. \$7.25

TAKE-UP SPRING #147500



\$4.25

SEWING MACHINE PARTS & ACCESSORIES (continued)

SEWING MACHINE STAND

\$325.00 complete
Specify Make & Model
With New Servo Motor

TOPS ONLY
(Call for Price)

Drawer
Motor
110v
PUSHBUTTON
SWITCH

"K"
LEGS
(OR "H")
ONLY
(Call for Price)

BALL
JOINT
ROD

TREADLE
AND BASE

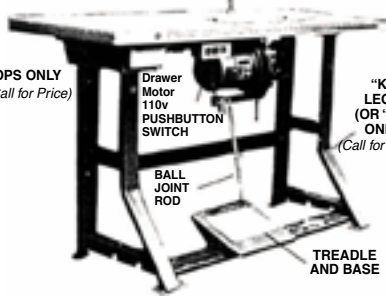

THREAD STANDS

1, 2, 3, spools stands available

1. 27449 \$9.75
2. 228776 \$14.50
3. 228777 \$29.95

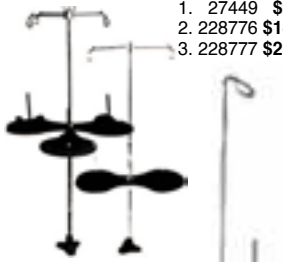

RUBBER LEG CUSHION
152210
\$3.95 ea



BLIND STITCH PARTS

BLINDSTITCH LOOPER

4039 \$39.95 Lewis Type
R2200 \$42.95 US Type



BLINDSTITCH LOOPER SINGER/DEARBORN

400041(937) \$32.00



FEED DOG BLINDSTITCH

2100 \$28.50



METAL CHAIN OFF
PIN BLINDSTITCH
1315U (X 15-1)
\$6.25

NEEDLE GUIDE
1238 (47) \$3.75



CYLINDER/SLEEVE TUBE for U.S. & Japanese Blindstitch Machines

Metal
Large
\$74.00



Plastic
Small
\$32.00

COMPLETE PRESSER FOOT ASSEMBLY for U.S., REX & OTHER BLINDSTITCH MACHINES

6101
\$339.00



110V "ON-OFF" PUSH BUTTON SWITCH BOX complete with Wire Harness

\$42.95



Switch Box
Only \$11.95

SPECIFY:
Motor Make
and Model
Clutch or
Servo Type

OVAL OR ROUND
RUBBER KNEE
LIFTER PAD
MP 15066 & (CKP2)
\$4.95



V BELT
SPECIFY:
Length
\$4.75



BELT PLIERS
\$72.00



LEATHER BELTING
Genuine Steer Hide. Belt
pier and hooks available.



BELT HOOKS
FOR ROUND
LEATHER BELTING
16B4 1 dozen \$1.20

per foot
\$2.35

BUTTON HOLE ATTACHMENT

IBA 10 Model "D" for Industrial Machines
PDA 20 Model "C" for family machines

\$198.00



EURO METAL HINGE PINS
143882-0-01
ea \$5.45



RUBBER HINGE
143910-01 \$5.45



OLD STYLE TABLE
HINGE HOOK
\$1.75
EACH



AUTO BOBBIN
WINDER
\$39.95 EACH



COMBINATION
BOBBIN WINDER
\$16.25



SEWING MACHINE CLUTCH MOTOR

Complete with built-in clutch, fully wired
with push button switch and light plug.
Adjustable height for belt tension. 110v,
1/2 hp., Reversible rotation. Continuous
run motor for BUTTON SEWERS also
available.

\$179.00



SERVO MOTORS

DIAL SPEED CONTROL ANALOG SERVO MOTOR

With carbon brushes. Same benefit as digital motor but simpler
to operate and change speed. 3/4 hp110v, 550 watt, 17 lbs.,
Speed 0-3450 RPM. Saves up to 70% electricity. **\$159.00**



DIGITAL CONTROL SERVO MOTOR

Brushless! It only runs when engaged. You can adjust the speed to your
need. 3/4hp, 110v, 600 watt, 12lbs., Speed 0-4000 RPM.
Saves up to 70% electricity.

\$169.00 Portable Machine Motors \$48.95



NEW! DIRECT DRIVE SERVO MOTOR

This motor is more efficient saves 60% to 80% energy.

ELIMINATES BELT & MOTOR BELOW THE TABLE!
It mounts on shaft at right end of your machine,
as this photo shows. Eliminates noise, vibration,
belt dust, includes needle position, bobbin
winder & led light. Easy to install, light weight.
(No holes to drill) Easy single stitch button.
Easy speed control 0-4500rpm, 550w/110v

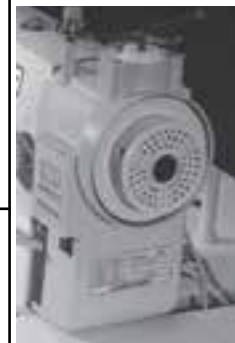

MADE TO
FIT MOST
SINGLE
NEEDLE
LOCK
STITCH
MAKES &
MODELS

\$139.00

CONTINUOUS RUN MOTOR

for Button Sewers and
Tackers. 110v/220v,
1/2 HP, 1425 RPM
\$179.00



MACHINE OIL

1 Quart - \$12.95
Zoom Sroul - \$3.45
1 Gallon - \$36.95



MACHINE NEEDLES

NEW



AMF

Needles available in size 9 (65 extra fine, 11 (75) fine, 12 (80) medium fine, 14 (90) medium, 16 (100) medium heavy, 18 (110) heavy. Regular or ball point. Be sure to state make and model number and/or needle system and size when ordering. Also regular or ball point. Sizes may be assorted.



GROZ-BECKERT

AMF STRAIGHT STITCH NEEDLES

SYSTEM	SIZES	Mix Sizes	PRICES
16 x 231	12, 14, 16, 18	}	\$16.50 per 100
135 x 5	12, 14, 16, 18		\$16.50 per 100
175 x 1	16, 18		\$26.50 per 100

ORANGE STRAIGHT STITCH NEEDLES

Regular or Ball Point

100 Same Size	\$21.95	50 Mixed	\$13.95
100 Mixed	\$25.95	10 Same	\$3.95

SYSTEM	SIZES	PRICES	PRICES
16 x 87, 16 x 1	11, 12, 14, 16, 18, 20	[Full Boxes of 100, Same Size]	\$21.95
16 x 231	12, 14, 16, 18, 20		\$22.25
134R	12, 14, 16, 18		\$22.25
88 x 1	12, 14		\$22.25
1955 135 x 5	12, 14, 16, 18		\$22.25
B-27	12, 14		\$22.25

SYSTEM	SIZES	PRICES	PRICES
135 x 17	12, 14, 16, 18, 20, 22	\$3.25 per 10	\$26.95 per 100
175 x 1 RS TQXI	16, 18	\$3.85 per 10	\$31.50 per 100
175 x 1 FS	16, 18	\$3.85 per 10	\$31.50 per 100

AMF BLIND STITCH NEEDLES

SYSTEM	SIZES	PRICES
LW x 5T/251 LG	90/14/25	\$35.00 for 50
LW x 6T/29 x 49	65/9/2, 5/11/2½, 8/12/3	\$8.00 for 10

ORANGE BLIND STITCH NEEDLES

Regular or Ball Point

SYSTEM	SIZES	PRICES
251 Short / LW x 3T	1½, 2½, 3½, 4	\$49.95 per 50
251 Long / LW x 5T	10, 15, 20, 25, 30	\$49.95 per 50
		\$6.50 packet of 5

SYSTEM	SIZES	PRICES
29 x 34 / LW x 2T	2½, 3½, 4, 8	\$49.95 per 50
29 x 49 / LW x 6T	2½, 3, 3½, 4	\$49.95 per 50
		\$13.25 packet of 10

BUTTONHOLE MACHINE NEEDLES

SYSTEM	SIZES	PRICES
SY558 SUZUKI	11, 14	\$26.50 per 50
750 (SC) REECE	11, 14	\$46.95 per 100

COVER STITCH MACHINE NEEDLES

SYSTEM	SIZES	PRICES	PRICES
B-63	11, 12 SRB	\$4.95 per 10	\$46.95 per 100
UY128 GAS	11, 14 Liebersew, Juki, etc.	\$4.95 per 10	\$46.95 per 100

HOME MACHINE NEEDLES

ORANGE HOME SEWING MACHINE NEEDLES

SYSTEM	SIZES	PRICES
15 X 1	9,10, 11, 12, 14, 16, 18	\$17.25 per 100
		\$7.15 for 25

SCHMETZ HOME SEWING MACHINE NEEDLES

SYSTEM	SIZES	PRICES	PRICES
130 x 705 HS Knits	11, 14	\$7.25 per 5	\$33.95 per 50
130 x 705 HJ Jeans	12, 14, 16, 18	\$6.35 per 5	\$29.95 per 50
130 x 705H Normal	8, 9, 10, 11, 12, 14, 16, 18	\$3.85 per 5	\$17.25 per 50
130 x 705H LL Leather	14, 16, 18	\$6.35 per 5	\$29.95 per 50

COVERPRO SCHMETZ

SYSTEM	SIZES	PRICES	PRICES
130 X 705EL	14	\$8.25 per 10	\$39.95 per 50

SCHMETZ DOUBLE NEEDLES

SYSTEM	SIZES	PRICES
130/705 HZWI	#10, 1.6 Spacing	\$5.25 each
130/705 HZWI	#12, 1.6, 2.0, 2.5 Spacing	\$5.25 each
130/705 HZWI	#14, 3.0, 4.0 Spacing	\$5.25 each
130/705 HZWI	#16, 4.0, 6.0 Spacing	\$5.25 each

SCHMETZ, GROZ-BECKERT STRAIGHT STITCH

Regular or Ball Point

SYSTEM	SIZES	PRICES (per Same Size)
175 x 1	16, 18	\$37.50 per 100 \$28.50 per 50 \$7.60 per 10
16 x 1	11, 14, 16, 18	\$37.50 per 100 \$28.50 per 50 \$7.60 per 10
16 x 95	8, 9, 10, 12, 14, 16, 18	\$37.50 per 100 \$28.50 per 50 \$7.60 per 10
16 x 231	8, 9, 10, 12, 14, 16, 18	\$37.50 per 100 \$28.50 per 50 \$7.60 per 10
16 x 257	8, 9, 10, 12, 14, 16, 18	\$37.50 per 100 \$28.50 per 50 \$7.60 per 10
135 x 5	8, 9, 10, 12, 14, 16, 18	\$37.50 per 100 \$28.50 per 50 \$7.60 per 10
135 x 7	8, 9, 10, 12, 14, 16, 18	\$37.50 per 100 \$28.50 per 50 \$7.60 per 10
134R	8, 9, 10, 12, 14, 16, 18	\$37.50 per 100 \$28.50 per 50 \$7.60 per 10
88 x 1	12, 14, 16	\$37.50 per 100 \$28.50 per 50 \$7.60 per 10
B x 27	11, 14	\$37.50 per 100 \$28.50 per 50 \$7.60 per 10
135 x 17	14, 16, 18, 20	\$37.50 per 100 \$28.50 per 50 \$7.60 per 10

SCHMETZ, GROZ-BECKERT BLIND STITCH NEEDLES

SYSTEM	SIZES	PRICES (per Same Size)
251 LG / LW x 5T	10, 15, 20, 30	\$24.50 for 10 \$87.50 for 50
29 x 49 / LW x 6T	1, 1½, 2, 3½	\$24.50 for 10 \$87.50 for 50
251 Short / LW x 5T	2, 3	\$24.50 for 10 \$87.50 for 50

MAIER AND STROBEL BLIND STITCH NEEDLES

SYSTEM	SIZES	PRICES	PRICES (per Same Size)
251EU	15, 20, 25	\$21.25 for 10	\$83.75 for 50

SCHMETZ, GROZ - BECKERT SERGING NEEDLES

SYSTEM	SIZES	PRICES	PRICES (per Same Size)
BL x 1	11, 14	\$4.35 per 10	\$39.95 per 100
DC x 27, B 27, DC x 1	11, 14	\$4.35 per 10	\$39.95 per 100
16 x 75	11, 14	\$6.95 per 10	\$32.95 per 50
16 x 71	11, 14	\$5.75 per 10	\$27.50 per 50
88 x 1	12, 14, 16	\$4.30 per 10	\$37.95 per 100
UY154G Curved	12, 14	\$18.25 per 10	
151 x 1 (60M) curved	11, 14	\$18.25 per 10	

SCHMETZ LEATHER MACHINE NEEDLES

SYSTEM	SIZES	PRICES (per Same Size)
16 X 230	12, 14, 16, 18	\$47.95 per 100
135 x 17	12, 14, 16, 18, 20	\$47.95 per 100

LEATHER NEEDLES for HOME MACHINE

SYSTEM	SIZES	PRICES (per Same Size)
15X2NTW/130705HLL	12, 14, 16, 18	\$6.25/10 \$29.95/50

INDUSTRIAL MACHINE NEEDLEGUIDE

MAKE	MODEL	NEEDLE SYSTEM
Bernina	217	16 x 231
	217 N	135 x 7
	940, 950	16 x 95
Brother	B755-3, B651	16 x 231
	B763, 524	
Chandler	481 Flat Shank,	175 x 1
	485-P, Round	(16# recommended)
Chandsew	581 Flat Shank,	175 x 1
	585-P Round	(16# recommended)
Consew	100, 101, 207, 210, 215	16 x 231
	216, 217, 220, 230, 199R	16 x 95
Juki	206RB, 226R-1	135 x 17
	DDL 201, 227, 555, 5530	16 x 257, 16 x 231
Liebersew	8500, 8300, 8700	
	WF, 0628	135 x 17
	COV, W-122, LS-562	UY 128 GAS
	STR, 8700, 550, 8500	16 x 231, 16 x 257
	BLS CM500, CM101	29 x 49
	BUTT 1377 373X	175 x 1
	SERG 737	B27 DC x 1
	ZIG 20U93	135 x 5
Marrow	A.M.SY	151 x 1 / 60M
Pfaff	463, 138	134
	260, 269	130 x 705H
Rex	215, 345	16 x 231
Singer	31-15	16 x 11, 16 x 87
	95-10, 96-10, 96-80	16 x 231
	103K, 196-K, 188-K, 188U	
	20U, 281-1, 281-3	135 x 5, 1955
	281-20, 281-22, 281-23	
	491, 191, 591, 1191, 1591	
	111W, 211	135 x 17
Union Special	39500	UY154G

HAND SEWING NEEDLES, PINS, PIN CUSHIONS, TOOLS AND THIMBLES

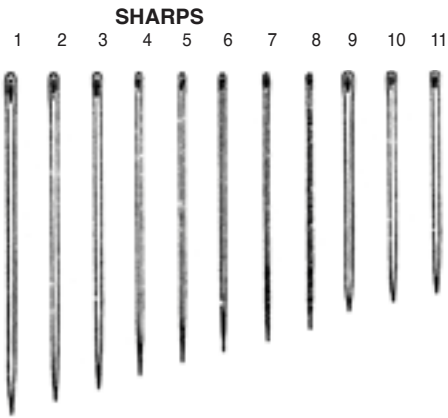

THOMAS & SON pack of 20

Sharps 1, 2, 3, 4, 5, 6, 7, 8, 9, 10, asstd. $\frac{1}{8}$, $\frac{1}{16}$ **\$1.70**
 Betweens 3, 4, 5, 6, 7, 8, 9, asstd. $\frac{1}{8}$, $\frac{1}{16}$ **\$1.75**
 Embroidery Crewel 6, 7, 8, 9, 10, asstd. $\frac{1}{8}$, $\frac{1}{16}$ **\$1.75**

JOHN JAMES pack of 25

Sharps 1, 2, 3, 5, 7, 9 asstd. $\frac{1}{8}$ **\$2.25**
 Betweens 1, 3, 5, 6, 7, 9, asstd. $\frac{1}{8}$ **\$2.15**
 Beading.....11,12,13 card of 3 **\$2.35**
 Darning Needles 5, 7 $\frac{1}{8}$ **\$1.64**

GLOVER
Leather Handsewing Needles **\$11.95**
Sizes.....1, 3, 4, 5, 7, 20 per pack
 Three sharp edges, tapered points prevent tearing of leather.

THIMBLES

Open Top 6, 7, 8, 9, 10, 11. **\$3.99**
 Nickel plated Order by size.
 Closed Top 6, 7, 8, 9, 10, 11. **\$4.25**
 Nickel plated. Order by size.
 Sterling Silver Thimble **\$62.95 & UP**



TOOLS FOR THE TRADE

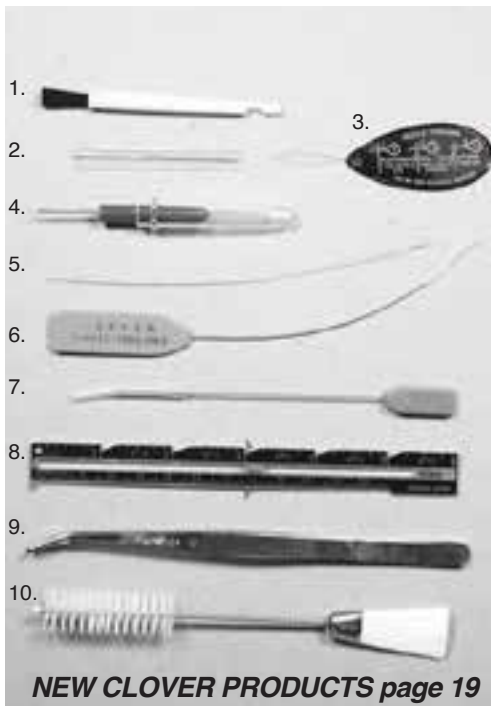

NEW CLOVER PRODUCTS page 19



BETWEENs

BEADING

10 12 13

CREWEL EMBROIDERY

6 7 8 9 10

DARNING

3 5 7 9

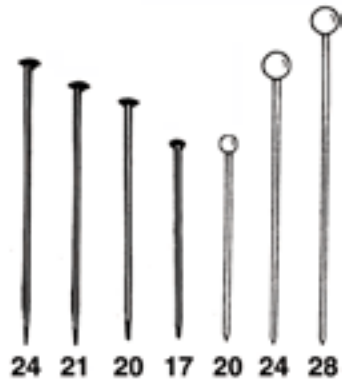

LEATHER

1 3 4 5 7

PLASTIC BALL HEAD PINS

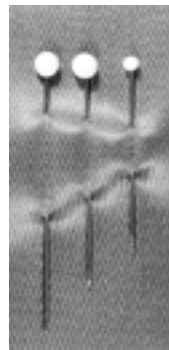

#20 1 1/4" 2500 **\$31.49**
 #24 1 1/2" 2500 **\$27.75**
 #28 1 3/4" 2500 **\$28.95**

BEST QUALITY!!
BEST SELLER!!
#21 SATIN PINS
 Extra Fine, Long
 1lb **\$15.75**

#17 SATIN PINS 1lb box
 1-5 boxes **\$12.00** each
 6 + boxes **\$11.00** each
 20 boxes **\$12.00** each



DRESSMAKER STEEL PINS
 #17, #20, #24
 1lb per box
 1-5 boxes **\$9.95** each
 6 + boxes **\$9.49** each
 20 boxes **\$9.10** each



NEWAY DORCAS PINS Nickel Plated #23

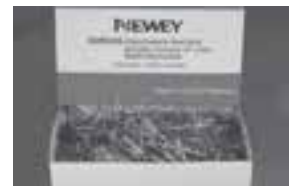

\$29.25

T-PINS

#20 **\$11.95**
 #24 **\$9.40**
 #28 **\$9.40**
 #32 **\$10.49**

each 1/2 lb per box **\$11.90**

TOOLS FOR THE TRADE

1. **Serger Needle Inserter** with brush **\$3.09**
2. **Snag Repair Tool** for knits and wovens **\$1.85**
3. **Needle Threader** **\$0.79**
4. **Knit Picker** for snags on knits and wovens **\$2.25**
5. **Twisted Threading Wire** for overlock machines **\$2.35**
6. **Serger, Looper & Needle Threader** **\$3.09**
7. **Serger Needle Threader** **\$2.35**
8. **Measuring Gauge** for precise work with movable indicator for inches and centimeters **\$1.49**
9. **Tweezer Long 6"** **\$2.59**
10. **Sewing Machine Lint Brush** **\$3.09**



GLASS HEAD PINS
 1 card 200 **\$5.25**

QUILTING PINS



500 per box **\$8.45**

Classic Forged

Fully Forged, Nickel-Plated



426-4 (old #102-4) 4" Embroidery Scissors **\$10.95**
426-4curv 4" Curved Embroidery Scissors **\$11.95**
426-5 (old #102-5) 5" Embroidery Scissors **\$13.50**



437-5 (old #202-6) 6" Sewing Scissors **\$20.95**
801 4 1/2" Thread Scissors **\$14.49**



HIGH GRADE STEEL
5.5" TAILORS POINT
\$14.95



HIGH GRADE STEEL
5" EMBROIDERY
\$12.95



HIGH GRADE STEEL
4" EMBROIDERY
\$11.95



Your Scissors for Life

Cushion PRO

Stainless Steel Blades, Molded Handle

960-8
8 1/2" Heavy Duty
Lightweight Trimmers
\$13.95



990-10
10 Heavy Duty
Lightweight Trimmers
\$16.95

Industrial Forged

Fully Forged, Nickel-Plated

270-7 (old #455-7)
7" Bent Trimmers
\$25.95



270-8 (old #455-8)
8" Bent Trimmers
\$26.95

270-8SR (old #454-8)
8" Serra Sharp Bent Trimmers
\$28.95



271-8 (old #455-8LH)
8" Left Hand Bent Trimmers
\$28.95

490-9 (old #429-9)
9" Heavy Duty Bent Trimmers
\$36.95



49010X (old #420-10)
10" Bent Trimmers
\$42.95

490-12 (old #4522-12)
12" Bent Trimmers
\$49.95



493-10 (old #420-10LH)
10" Left Hand Bent Trimmers
\$49.95

Stainless Steel Blades, Molded Handle

601
Thread Clip
\$6.95



668
4 1/4" Embroidery Scissors
\$8.25

664
5 1/2" Scissors
\$8.75



660
8" Bent Trimmers
\$12.25

690
9" Bent Trimmers
\$14.95



BP665 8 1/2" Pinking Shears
Molded Handles
\$24.95

SCISSORS, CLIPS and SHARPENERS

gingher



- G-4W 4" embroidery chrome-plated **\$26.95**
- G-8 8" knife edge bent trimmers **\$35.95**
- G-8L left hand chrome-plated **\$36.95**
- G-10 10" knife edge bent trimmer nickel-plated **\$46.95**

"TWICE AS SHARP"

A scissors sharpening system to match all possible angles. Comes with a comprehensive training video.

- Weighted - Boxed 14lbs., unit only 12lbs.
- Voltage - 110-130 a.c. 60 cycle, Wattage 373,3450 rpm
- Sharpening Arms - Double-sealed Rulon® bearings, no maintenance required.
- Sharpening Clamp - Set angles from 0°-57° degrees clamp opens to 3/4" of an inch
- Sharpening Wheel
- Honing Wheel



\$499.00

5" Knife-Edge Craft Scissors

\$27.95



Pocket Sharpening Stone

3-Inch x 7/8-Inch



\$4.95

PANT PINKER & SWATCH CUTTER

12" wide blade for pinking pants bottoms Boards and Blades are replaceable. Instead of pinking shears, use this cutter and save your hands!

\$895.00

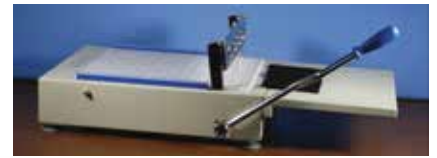

PROFESSIONAL TAILOR SHEARS

10" and 12" Forged from German Steel 10" **\$21.95**
 Excellent Quality, Extremely hard edges. 12" **\$23.95**
 Made in China



FISKARS



Softgrip easy action spring assist scissors for effortless cutting.

10 1/2" **\$19.95**



Micro-Tip Spring Assist Thread Cutter, 6"
\$14.25



FISKAR BLADE SHARPENER

Slide the blades with a closing motion approximately 4 times for a new blades edge. **\$16.95**



Folding Scissors

\$3.95

KAI SHEARS

High Quality Blade, Ergonomic Handle



8" **\$34.95**
 11" **\$49.95**



Made In Japan

WISS HEAVY DUTY SHEARS

No. 20 10" **\$39.95**
 No. 22 12" **\$44.95**



WISS #1570 QUICK-CLIP
 4 3/4" **\$6.75**



WISS TC1 STEEL-CLIP
 Sharp Points **\$13.75**



IMPORTED THREAD CLIPS METAL \$1.95



THREAD CLIPS PLASTIC \$2.95



NEW

PINKING SHEARS

Always a perfect cut
 Siempre un corte perfecto

10 1/2" **\$42.00**



FINNY SHEARS

Made in Germany by KRETZER stainless steel comfortable handle

8" **\$26.95**



5" **\$22.50**



10" **\$45.95**



SEAM RIPPERS, BLADES, CUTTERS, ROTARY SHEARS

SEAM RIPPERS



LARGE DOUBLE SEAM FIX
WITH RUBBER TIPPED
THREAD REMOVER.
\$6.95 each



OLFA CUTTER SEAM RIPPER
Our customers love this tool for ripping
seams and cutting off buttons.



Snap-off
segments
provide 36 new
razor-sharp
edges.
each **\$2.30**

REFILL BLADES
Pack of 10
\$4.95
Box of 50
\$18.95



**SINGLE EDGE
RAZOR BLADES**
\$6.25 Per 100

NEW Precision SEAM RIPPER
curved blade and a spare.
Plus a **BUTTON HOLE BLADE**

Creating button holes has never been easier!
\$2.75

SMALL SEAM FIX
WITH RUBBER TIPPED
THREAD REMOVER.
\$3.25 each



**ERGONOMIC
OLFA
ROTARY
CUTTER**
\$20.95

*Fits both
Straight
&
Pinker
Blades*

MINIATURE ROTARY SHEAR - AS100



Electric handheld, cuts layers of
cloth. Accurate for cutting out patterns or
pants bottoms. A **MUST** for custom tailors,
sample and alteration room.

\$189.00

Large Rotary Cutters also Available.



DIRECT DRIVE ROTARY CUTTER

with built in sharpener
4" blade, 110v **\$149.00**

CUSHION GRIP ART KNIFE AK-4

Antislip, acetone
resistant.
The bottom is
weighted
slightly for
better balance.
For right and
left hand use.
\$13.95



OLFA CUTTER REFILL BLADES
Pinking Rotary Blade Refill **\$9.95**
Regular Blade Refill **\$7.95**



CORDLESS RECHARGABLE 4" ROTARY KNIFE \$169.00



4" ROUND KNIFE CUTTER ZJ-100

Cuts fabric up to 1" thick
with 8 sided blade **\$159.00**
with built-in sharpener stone
Replacement Blade **\$19.50**
AN INDUSTRIAL MACHINE



**PRECISION
ART BLADE**
23° angle high
quality carbon
steel. Fits AK-4
& your old
XACTO Knife #4
\$6.25 Box of 5 w/ knife

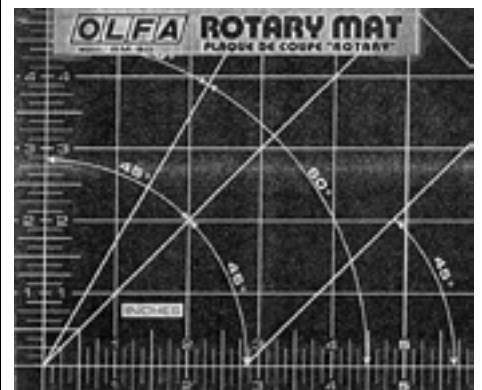

18"x24" **\$36.95**

24"x36" **\$47.95**

LAMPS, BULBS & THREAD RACKS

LED LIGHT



Mount to overhead thread stand pole to shine over whole work area.
110V

\$ 21.95



FLEXIBLE ARM LAMP



With Clamp Swivels, uses all standard bulbs.
\$25.95

GOOSE NECK LAMP
26" Neck with rocker switch with clamp **\$28.65**
without clamp **\$25.95**



MAGNETIC LED SEWING MACHINE "EYESHIELD" LAMP

"Touch On"

Elegant Design

\$19.95



LED 28K
Most popular Gooseneck light, value priced.
C-Clamp
\$33.50

LEDs are the most efficient and lowest cost to operate lighting available. They are rated for up to 60,000 hours of use.



THREAD RACKS

Smooth finished American hardwoods.
Strong spindles.
Convenient keyhole slots for easy hanging.

MIDSIZE CONE RACK
Stand up or hang up.
33 spindles.
\$25.95



LARGE RACK
Holds 60 spools
Stand up or hang up.
1 pc \$24.95 or 2 for \$39.00



DISPENSING THREAD RACK
Holds 24 Cones or Spools. Use it behind your straight stitch or Serger. Saves time changing threads and from having to leave the machine. Perfect to install between two back to back machines. Each operator will have 12 cones or spools for their machine.
\$49.95



MOFFATT INC

TODAY'S DESIGN - TRADITIONAL QUALITY

Cool lamp in spite of 100 WATT capacity. Aluminum heat sink surrounds bulb base. See cross section. Heavy duty FLEXARM allows full lamp movement 12 times around. Prevents eye strain. Uses any standard bulb.
LA01003 **\$56.95**



LAMP INCLUDES MOUNTING STUD.
OPTIONAL C-CLAMP AVAILABLE. \$ 15.95

MAGNIFIERS FOR MOFFATT

A handy, inexpensive way to get an illuminated look at what you're doing. The shade-mounted model measures 4"X 2" and fits any full size Moffatt light. It can swivel out of the way and comes with its own dust cover
\$24.00



CLEAR OR FROSTED BULBS EXTRA HEAVY DUTY

Long Lasting, Brass Contacts
6-8 volt bulb
#6VC (#194844) Clear Bulb.
#6VF Frosted Bulb. **\$3.95**



LED Light for Jukilock

SEALED BEAM BULBS FOR SINGER & DYNOLIGHTS

#996206 (#21233HJ)
6.3 volt, 17 watt **\$3.95**
#996207 Superior
120 volt, 30 watt **\$3.95**



HOOKS & EYES, SNAPS, VELCRO, JEAN BUTTON w/ TACK

ZIPPER REPAIR TOOLS

END NIPPERS

Nippers
\$19.95



Serve to attach zipper top stops & bottom stops.

NEEDLENOSE PLIERS

Pliers 6"
\$16.95



VELCRO HOOK & LOOP

Black, White, Foliage Green, Beige and OD.
White, Black 50 yard roll colors.
(prices are per roll)

5/8"	25yds	\$14.95
3/4"	25yds	\$9.95
1"	25yds	\$9.95
2"	25yds	\$16.80
4"	25yds	\$28.50

50yds.	\$15.95
50yds.	\$17.50
50yds.	\$30.80
50yds.	\$52.25



FOR TUX PANTS

AZ FASTENER REPLACEMENT TRACKS AND BUCKLES

100 tracks \$29.95

(set 2 buckles and 2 tracks)
\$3.25

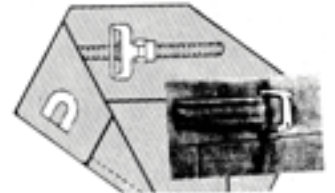

TROUSER & SKIRT CLOSURES In trays, 100 sets

NULOOK

Sew-on
100 Sets
Black \$26.95
Silver \$11.95



STAG

Sew-on
100 Sets
Black \$25.95
Silver \$10.95



ELITE

Clamp-on
Silver
70 Sets
\$11.95



NEW EUROPEAN HOOK & EYE TRAY

Sew-on 100 Sets \$15.75, Eyes only \$7.25



HOOKS, EYES, LOOPS Order by size

Sold by the gross

EYES

LOOPS

HOOKS

ASSORTMENT TRAY \$26.50

BRIDAL HOOKS & EYES sizes 1 & 2

White enameled. 20 Sets per card \$9.95 6 Cards \$18.50 12 Cards

\$7.29

\$7.29

\$10.50

\$5.75

\$14.50



1

2

3

7

FABRIC COVERED SNAP FASTENERS

Basic colors - 1 Dozen per Card, small & large.



small size #1
large size #4

\$8.50

DRESS SNAPS Order by size

\$10.65

\$13.65

\$14.45

\$20.95

\$3.95
per doz.
\$31.45 gross

\$4.15
per doz.
\$36.75 gross



4/16 3/16 2/16 1/16 1 3 4 7

Sew-on, Rust proof, washable, black & silver, by the gross.

CL00035 ASSORTED TRAY OF 3 SIZES. \$33.50 2/0, 3/0, 4/0

CL00036 CLEAR PLASTIC SNAPS

Cards of 20 sets

1 box of 6 cards \$10.45

2 boxes of 6 cards \$17.75



OSBORNE HOLE PUNCH, versatile. \$19.95



"SPECIAL" JEAN BUTTONS TRAY

Antique Silver and Gold, Bronze

100 sets \$21.95



Tools for every Task

Tools everyone will love!



CLOVER TOOLS

- | | | |
|----------|---|---------|
| #9508 | Bobbin Tower for 30 bobbins any type. No more tangles. | \$10.95 |
| #2507 | Pins for patchwork, 100 extra fine for detail work | \$8.50 |
| #3157 | Jumbo Wonder Clips 24 green 2 1/4", open wide | \$13.39 |
| #4910 | Thread pic, soft touch, leaves no marks, with cover | \$4.99 |
| #6026 | Thimble, flexible gum ring grips, prevents slipping. S, M | \$6.59 |
| #6017-18 | Thimble, openside, adjustable. Good for long finger nails. S, M | \$6.95 |

CLOVER TOOLS

- | | | |
|-------|--|--------|
| #472 | Loop turner. Just clip and push to easily turn fabric. For cording, elastic & batting strips | \$5.50 |
| #806 | Spring tape measure, 60in | \$4.39 |
| #462 | Double Needle Threader | \$4.25 |
| #9506 | Sliding gauge, five uses, circle compass | \$8.99 |
| #495 | Finger (seam) presser, Flattens seams without ironing. | \$5.50 |
| #455 | Thread cutter with circular blade, pendant or stationary. | \$4.79 |
| #5031 | Air Erasable Pen | \$4.25 |



SUPERIOR MAGNETIC GAUGE #MG1 (#LGM)

- Enables stitching perfectly even seams along straight edges
- One piece magnet, made of a special unbreakable composite

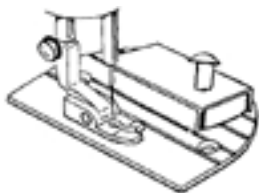

- Can be used anywhere on any machine
- Left of right of presser foot
- Adjusts for different seams widths instantly

\$2.95

MAGNETIC PIN HOLDER, BOBBIN HOLDERS



- | | |
|---------------------------------------|--|
| 1
MAGNET
\$0.99 | 2
WRIST FELT
PIN CUSHION
\$3.25 |
| 3
MAGNETIC
PIN HOLDER
\$4.95 | 4
MAGNETIC
GRABOBBIN
\$6.95 |
| 5
GRABBIT
with pins
\$6.95 | 6
MAGNETIC
WRIST PIN
HOLDER
\$7.95 |
| 7
BOBBIN
SAVER
\$6.45 | |

PLUSH PIN CUSHION WITH WRIST SNAP ON



**SPECIAL
\$4.95**

THE "ORIGINAL" Tomato Pin Cushion

cute & functional

\$1.15



TAILORS AND ALTERATION SUPPLIES

FAIRGATE

RULERS AND CURVES

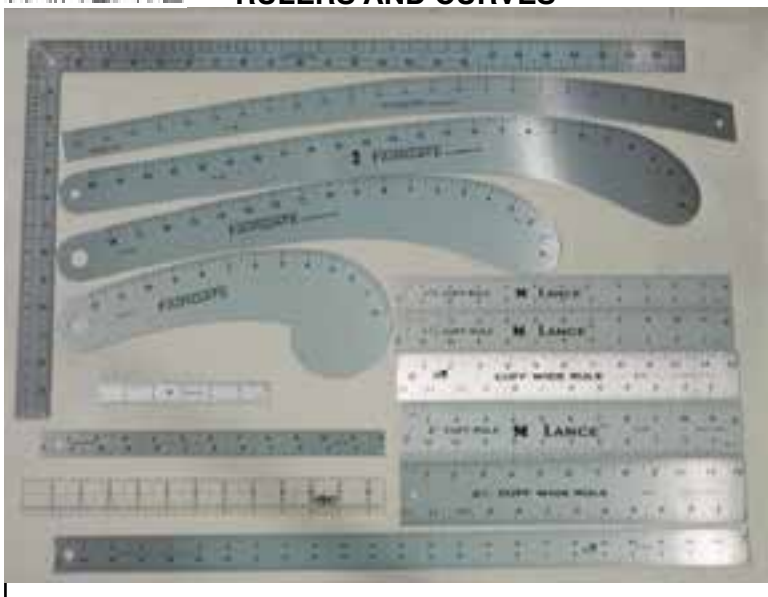

L SQUARE	24"	\$27.75
CURVE STICK	24"	\$19.95
VARY FORM	24"	\$20.95
VARY FORM	18"	\$19.95
VARY FORM	12"	\$18.95
METAL RULER	6"	\$3.15
STRAIGHT EDGE	7/8" X 12"	\$5.95
PLASTIC CLEAR	12"	\$8.95
STRAIGHT EDGE	24"	\$8.95
STRAIGHT EDGE	36"	\$16.45
CUFF RULE	1" X 12"	\$5.95
CUFF RULE	1 1/4" X 12"	\$6.20
CUFF RULE	1 1/2" X 12"	\$6.45
CUFF RULE	1 3/4" X 12"	\$7.50
CUFF RULE	2" X 12"	\$8.50
CUFF RULE	2 1/4" X 12"	\$8.95
T SQUARE (not shown)	24"	\$18.95

TROUSER MARKER

Wooden **\$19.95**

Place the Trousar Marker over the front of the shoe. Resting against the shin vertically using a pin or chalk, make a mark on each pant leg. This reference mark will be 12 inches from the floor every time.

**saves time
marking cuff length
Eliminates mistakes**



TAPE MEASURES

120" VINYL WIDE

\$1.49

B&G VINYL with crotch piece.

\$0.94

VINYL 60"

Without crotch piece

\$0.75

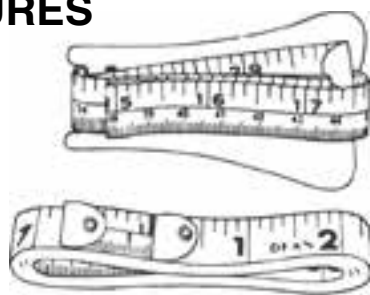

NOTCHED RULERS

6" sleeve rule **\$6.45**

20" hem rule **\$12.95**



**300 cent. & 120" round
retractable**

TAPE MEASURE

\$5.45

TRADITIONAL MODEL FORMS

From **\$499.00**

Male 38-48



**Children's, Men's, Missy's,
Women's and Pant Forms.**

Collapsible Shoulders.

**Footpedal release Model
for
height adjustment.**

Please call for information.

**Male forms available
short or long.**

**Custom size forms also
available.**

Call for pricing

From **\$499.00**

Female 2-18



ADJUSTABLE DRESSFORMS

Size Range	Bust	Waist	Hips	Neck	Back Waist Length
A-Small #1750A	33"-39"-1/2"	25-1/2"-32-1/2"	36"-42"	13-1/2"+	15"+(or -1)
B-Medium #1751B	39-1/2" - 45-1/2"	31-1/2" - 38"	41" - 47"	14"+	16"+(or -1)



TWIN-FIT

- Auto -set dials-Press & turn for easy adjustments
- Adjustments can be made in 1/2" increments
- Classic gray color
- Foam-backed nylon cover for pinning and marking
- Adjustable neck with pin cushion
- New Body Shape
- Longer Back Waists Length
- 8 Auto-Set Dials
- Hem Leveler
- Metal Tripped Stand

From \$179.00

Call for prices.

FASHION MAKER DRESS FORMS

Adjustable height, bust, waist, hips, neck & back. Sturdier Model than TWIN-FIT
2, 4, 6, 8, 10, 12, 14, 16.

Please call for prices.

TAILORS CHALK & MARKING ITEMS



TAILORS CHALK #3001
PMC made in USA since 1906
32 pcs. **\$8.95**



TAILORS CHALK #3050
PMC made in USA
GIANT, 32 pcs. \$9.95



TRIPPLE WARE
Special Process, USA
32 pcs. **\$8.95**



**PERFECTION MASTER
DISAPPEARING WAX CHALK**
999SLO
disappears after 120 hrs, 36 pcs.
\$47.95



PANDA CHALK
wax, thinner, sharper, rounded
corners, use light touch, 50 pcs.
\$5.95



RABBIT CHALK
Vaporizable Tailor's Chalk
New Design for easier marking
EXTRA THIN
\$7.95



SUPER-GLIDE
B&G brand, wax, 48 pcs.
1/4" groove for good grip
\$12.45



JEM'S OLD TAILOR CLAY CHALK
clay, #300, 36 pcs. **\$11.95**



MULTI MARK, Water Soluble
Six colors in ONE pen to mark
fabric w/water
disappearing mark. **\$10.95**



Zipper EASE, \$2.25

BEE'S WAX CAKES
\$1.49



SULLIVAN'S CLAY CHALK

RED
BLUE
WHITE
YELLOW
12 Asstd. Pcs.

\$3.49



ERASABLE MARKING INK PENS ea. **\$2.95**



AUTO-VANISHING INK PEN
Good for DELICATE FABRICS
They will not leave residue
each **\$3.25** per dz **\$33.00**

Air, Heat & Water Vanishing Pens

Water Erase Pen **\$2.95** 

Air Erase Pen **\$2.95** 

Heat Erase **\$2.95** 

Disappearing Marking Pens & Pencils Combo Set (6)
\$14.95



CHALK PENCILS white, red, yellow **\$1.49** ea.
CHALK PENCILS **\$12.95** per dozen
WAX CRAYONS white only **\$6.95** per dozen

B&G LIEBERMAN EXCLUSIVE CHALK SHARPENER (Plastic)

To have perfect fittings,
always sharpen your chalk



\$13.75



CHALK WHEEL
to draw powder chalk lines
\$2.95

SKIRT MARKER
with chalk **\$34.50**
w/o chalk **\$22.95**

Heavier squeeze tabs.
Chalk marks will not
rub off.



**REFILLS FOR YOUR
CHALK SKIRTMARKER
and CHALK WHEEL
above**



8 oz. **\$18.95**

WIGAN, PELLON, INTERFACINGS, FACINGS AND BINDINGS

FACINGS

COTTON/POLY BIAS HEM FACING-2"

White	Eggshell	Dk. Grey	Turquoise
Black	Dk. Brown	Med. Grey	Gold Camel
Navy	Lt. Grey	Md. Brown	Lavender
Kelly	Mint	Aqua	Lit. Blue

ON ROLLS25 Yds. **\$11.95**

COTTON FACING 1"

White, Navy, Black, Beige

ON ROLLS25 Yds. **\$8.95**

ACETATE BIAS HEM FACING-2"

White	Eggshell	Dk. Brown	Dk. Olive
Black	Lt. Grey	Taupe	Lt. Blue
Navy	Red	Beige	Wine
Dk. Grey	Camel	Med. Grey	Royal Blue

ON FLAT CARDS25 Yds. **\$12.95**

BINDINGS

CUFF BINDING, Cotton Herringbone

3/4" wide, 24 yds.

White, black, olive drab, natural, beige, navy, brown **\$7.25**

TAILORS STAY EDGE TAPE

1/4" wide, 100 yds.	\$18.50
1/2" wide, 100 yds.	\$24.20
3/4" wide, 100 yds.	\$36.30
1" wide, 100 yds.	\$42.35

APRON STRINGS, Nylon - White, Black, Navy

3/8" wide, 300 yds. **\$189.00**

BRAID

HORSEHAIR BRAID

1/4" 288 yds. \$74.95	1" 72 yds. \$49.95
1/2" 144 yds. \$49.95	2" 36 yds. \$39.95

HANGER BRAID

1/4" 144 yds. roll **\$44.99**

INTERFACINGS-YARDGOODS

Minimum 5 yard cuts.

FUSILON INTERFACING

45" wide WH yd. **\$5.49**

45" Black, white BL yd. **\$5.79**

PELLON "non-woven"

60" Black, white

wide, fusible per yd. **\$4.25**

FUSIBLE TRICOT

60" White, black 5 cut yds **\$4.95 per yd**

FINE FUSIBLE TRICOT

60" Black, white per yd. **\$5.45**

FUSIBLE ARMOWEFT

interfacing, white, black, charcoal

60" min. cut 5 yds. per yd. **\$5.45**

FUSIBLE ACRO

23" min. cut 5 yds. per yd. **\$12.95**

COTTON BIAS BINDING

Black, White, Brown, Beige

100 yd. roll 1/2" **\$17.95**

25 yd. roll 1" **\$10.95**

SHEER ORGANDY RIBBON

100% NYLON TAPE

100 meters, 9mm

wide for stabilizing seams

on knit garments.

Black, white. **\$18.95**



SATIN RIBBON 1/2" **\$19.95**

1/4", 3/8" **CALL FOR PRICING**

RIGILENE

6mm 1/4" white & black 50yd. roll **\$19.95**

12mm 1/2" white & black 50yd. roll **\$29.95**

SEAMBINDING

100 Yd. Roll



001 white	055 black
039 eggshell	159 gun grey
73 cream	098 charcoal
149 soapstone	156 silver
110 fig beige	173 kelly
154 hazelnut	175 canton green
41 camel's hair	34 jungle green
145 heathertan	171 mint green
147 sandstone	31 moss green
112 colonial brown	137 Dk. O.D.
117 mahogany	009 goldenrod
166 brique	74 mimosa
152 burnt rust	125 orchid pink
194 lake blue	006 siam pink
189 muted blue	106 peach
191 Losang blue	122 coral
142 midnight	103 fuchsia
183 powder aqua	71 bright red
180 lt. peacock	17 lipstick
177 turquoise	168 bordeaux
066 sea peacock	140 sweet grape
	198 pansy purple

each **\$10.95**

FABRI-LOC or WEB WONDERSTITCH

Iron-On Fusible
**GREAT FOR MENDING
AND QUICK HEMS!!**

50 yds 5/8" **\$6.75**

50 yds 1" **\$8.95**

100 yds 3" **\$26.95**

Black 13 yds 1" **\$3.95**



INTERFACING ON A ROLL

Fusible Wigan



FUSIBLE WOVEN WIGAN

	WH	BL
2", 100 yds., white, black	\$22.75	\$23.95
3", 100 yds., white, black	\$36.95	\$38.95

Nonfusible Wigan



NON-FUSIBLE BIAS WOVEN WIGAN

	BL	WH
2", 100 yds., white, black	\$19.95	\$18.25
3", 100 yds., white, black	\$28.75	\$29.95

Fusible Pellon



FUSIBLE PELLON

2", 100 yds., white, charcoal	\$15.95
3", 100 yds., white, charcoal	\$17.95

Fusible Tricot



FUSIBLE TRICOT INTERFACING

For thin fabrics.

2", wide 100 yds., white, black	\$16.75
3", wide 100 yds., white, black	\$23.95

LININGS, POCKETING, COVERCLOTHS & PADDING WAIST BAND MATERIAL

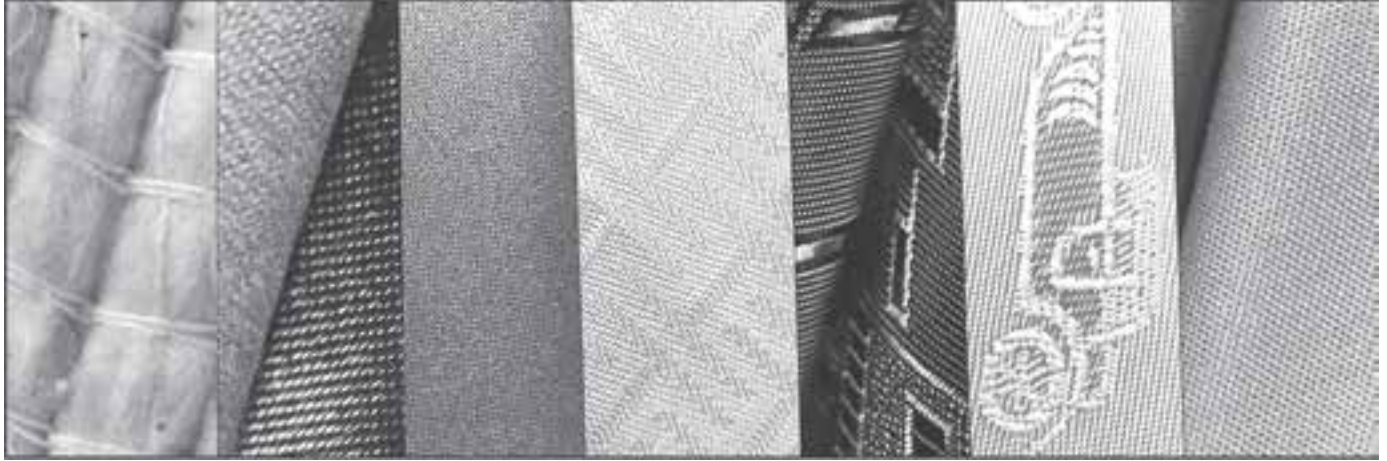

REGULAR SATIN

60" Wide, 220 count. Black, White, Beige, Dk. Brown, Navy, Taupe, Dk. Gray. 5yd piece per yard **\$6.45**

STRETCH POLYESTER LINING

Black, White, 5yd piece per yard **\$4.95**

COTTON

DRAWCORD
100 yds. **\$34.95**

BRIDAL SATIN

280 count. 60" Wide, Navy, Dk. Brown, Red, White, Camel, Black 5yd **\$8.95** per yard

LUSTERBACK

60" Wide, Flannel Back. An Excellent top coat lining. Black, Dk. Brown. 5yds **\$8.95** per yard

QUILTED LINING

60" Wide, for colder weather garments. Black 5yd **\$9.40** per yard

SLEEVE LINING

White SATIN STRIPE. 5yds **\$2.75** per yard

POLYESTER TWILL SUIT LINING

60" Wide, Black, Dk. Grey, Navy, Dk. Brown, Red, Beige. 5yds **\$3.45** per yard

ACETATE TWILL

60" Wide. Most common suit lining, 10 basic color available. 5yd **\$4.95** per yard

RAYON TWILL LINING

Finest quality for coats and vest 5 yds. to full roll. Black, Dk. Grey, Tan, Lt. Grey, Med. Grey, Brown 5yd **\$5.95** per yard

RAYON BEMBERG LINING

60" Wide, Dk. Grey, Med. Grey, Lt. Grey. 5yds **\$8.45** per yard

WAISTBAND MATERIAL

COVER CLOTH & PADDING

BLUE VACUUM TABLE CLOTH

54" wide 10 yds **\$19.95** per yd.

DRILL CLOTH for tables & presscloth.

72" wide 5 yds. **\$5.45** per yd.
50 yds. **\$4.95** per yd.

NYLON SPRINGBACK PADDING

50oz. 61" wide **\$34.50** per yd. for 3+ yds.
50oz. 61" wide **\$31.50** per yd. for 10+ yds.
20oz. 57" wide **\$15.50** per yd. for 3+ yds.
20oz. 57" wide **\$13.95** per yd. for 10+ yds.

NOMEX COVER CLOTH

61" wide White. Heat resistant
5 yds **\$55.00** per yd.
10 yds **\$49.00** per yd.

TROUSER POCKETING - 5 yard minimum

45" Cotton (cream & black) **\$5.25** per yard

WAISTBAND MATERIAL

2-1/2" with Ban Roll & Snugtex. White, Black 25 yds., or 50 yds **\$2.15** per yd.



XL90 WAISTBAND ELASTIC

25 yds. 1" **\$24.95**, 1-1/2" **\$32.95**

SNUGTEX Rubberized Waistband

1" White 50 yds. **\$24.95**

BANROLL

1" White 50 yds. **\$24.95** 1-1/2", 50yds **\$25.95**



FINEST BRAID ELASTIC

Dry Cleanable, Superior Stretch White, Black. 12 yd. rolls

Size	12 yds.	36yds.	144yds.
1/8"	-	\$10.50	\$29.50
1/4"	\$4.55	-	\$30.65
3/8"	-	-	\$39.25
1/2"	\$5.60	-	\$42.95
3/4"	\$6.45	\$16.65	-
1"	\$8.20	\$18.50	-
1-1/4"	\$11.25	-	-
1-1/2"	\$11.75	-	-
1-3/4"	\$12.30	-	-
2"	\$12.75	-	-
2-1/2"	\$13.25	-	-
3"	\$13.95	-	-



PREMADE Heavy Cotton Pockets for trousers

Cream & Black

6 Pair
\$ 9.69



NON ROLL RIBBED ELASTIC

White
1-1/2" 12yds. **\$14.95**
2" 12yds. **\$17.25**

BEST NON-ROLL ELASTIC

Prevents waistband roll-over. Dry cleanable, White, Black, 12 yds Black 3/4" and 1" only!
3/4" **\$9.25** 1" **\$9.15** 1-1/4" **\$10.15**



MEN'S SHOULDER PADS

Per Dozen Price



**# 619 Men's Shoulder Cotton Filled
Pellon Backing 9 3/4" x 4 x 1/4"**

Heavy 3/4"	Regular 1/2"	Thin 1/4"
\$29.50	\$28.25	\$27.50



**# 7170 Reversible, Cotton Filled,
Pellon Both Sides 9 x 4 3/4" x 3/8"**
1 dozen pair

\$32.95



**Perry Ellis - Felt Covered, Cotton
Filled, Reinforced 9 3/4" x 4 x 1/4"**

Heavy 1"	Medium 3/4"	Thin 1/2"
\$48.50	\$47.00	\$45.00



**# 735 Felt Layered, Best Quality,
Good Construction, 10 1/2" x 5" x 5/8"**

\$47.95



**EB - Black Double Felt, Cotton Filled
10 1/2" x 6 1/4" x 1/4"**

\$38.50



**HUGO - Double Felt, Stamped Cotton
Fill, Excellent Construction
10" x 5 1/2" x 1/4"**

\$47.50



**Harris Double Felt, Cotton Filled,
with Triangle Reinforcement**

10" x 6" x 3/4"
1/4", 1/2", 3/4"

\$38.50



**# 3033 Double Felt, Cotton Filled,
Reinforced Contour
9 1/2" x 5" x 1"**

\$38.50

Excellent when extra padding is needed.



MELLO - Mellotherm 3/8"
Black, White
10 1/4" x 5" x 3/4"

\$43.95



**\$21.00
per dozen**
Sleeve heads, 1/8"



Neck Pads, 1/6"
\$32.95 per dozen



ECONO Neck Pads
\$32.00 per dozen
5 1/2" x 4 1/4"



Blade pads, 1/8"
\$32.50 per dozen

LADIES'S SHOULDER PADS

Per Dozen Price

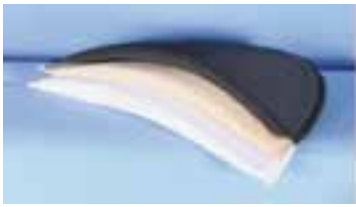

C9 Taffeta Covered Foam
7-1/2" x 4-1/4" x 1/4"
Nude, Black, White
\$12.45

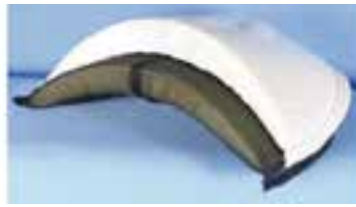

801 Taffeta Covered Foam
8" x 5" x 5/8"
White, Black
\$32.95



MOLLY-Layered Felt
Rounded Edge
8" x 5" x 1/4"
White
\$17.20



GRACE-Layered Felt
Countour Edge Rounded Corners
6-1/4" x 4-3/4" x 1/4"
White
\$14.50

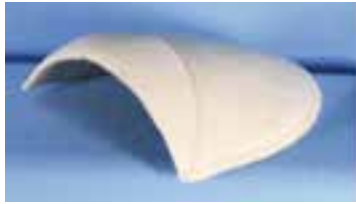

RAGLYN-Tricot Covered
Layered Fiber Rounded Edge,
Well Finished 5-1/2" x 5" x 1/4"
Nude, Black, White
\$39.95



EDGE Tricot Covered
Layered Fiber, Well Finished
8" x 4-1/4" x 1/2"
Nude, Black
\$36.50



MARIANNE
Tricot Covered, Fiber Layers, Rounded,
Very Precise, Well Finished
5-1/2" x 5-1/2" x 3/8"
Nude, Black, White
\$35.75



MARTHA - Tricot Covered,
Molded
Fiber, Rounded Edge
7-1/2" x 5-1/4" x 1/2"
Nude
\$39.95



TAMMI - Tricot Covered,
Molded Fiber
5-1/4" x 6" x 1/2"
Black, White, Beige
\$54.95



GAYLE- Covered Foam
Small Rounded
4-1/4" x 5-1/4" x 3/4"
Black, White, Beige
\$31.50

BRA CUPS

Per Dozen Price



PUSH UP BRA CUPS
Tricot Covered, Shaped Foam
Size B - Black, White, Beige \$36.95



2219 TEAR DROP BRA CUPS
Tricot Covered Foam
Black, White, Beige
A, B, and C Cups
\$32.95



ROUND #14 BRA CUPS
Tricot Covered Foam
Black, White, Beige
A, B, and C Cups
\$32.95



IMPORTED BRA CUPS
ROUND
Tricot Covered Foam
Black, White, Beige
Size B Cups Only
\$28.50

PUSH UP GEL CUPS
Size B - Heavy White \$32.95

TAILORS AND ALTERATION SUPPLIES



MAGNA-TAC 809 \$13.49
Adhesive for fabric, glass, pearls and other bridal ornaments. 8 oz.

GLUE STICK \$1.45
For fabric or leather. Washable, non-toxic.



BARGE CEMENT
Excellent for Leather Repair
1 Quart \$28.95
1 Tube \$7.25



FRAY CHECK
DOUBLE \$3.95
SINGLE \$2.95

DOUBLE FACED TAPE
For temporary hemming Leather & Ultra Suede

1/4"	36 yds.	\$3.25
1/2"	100 yds.	\$5.95
3/4"	100 yds.	\$6.95



LINGERIE GUARDS
Grosgrain ribbon, plastic snap
black, white, beige
1/2 gross pair
\$49.95



STRAP ADJUSTERS
Rings and Sliders for Bras and Swimsuits
\$44.95
By the dozen
1/4", 1/2", 3/4" Plastic
\$4.95

ALTERATION TAGS
2-part tags with button slot for easy use. Special order tags available with or without customer imprint.
With button slot per 500 **\$15.95**
With string per 500 **\$24.00**
Minimum order 10M for imprinted custom orders.



HEAVY KNIT RIB CUFFS & WAISTBAND
Black, Dk. Brown, White, Navy
Cuffs doz. pair **\$25.50**, WB doz. **\$55.50**



SUEDE LEATHER ELBOW PATCHES
Prestitched - 4 3/4" x 6 1/4"
Navy, Beige, Black, Dk. Brown
\$4.95 pair 6 + \$4.55 pair



BOOK & TEACHING MANUALS

Choose from an excellent selection of Manuals to help your salespeople and alteration staff.



English and Spanish in one book!

Explicit Terminology for altering garments and using equipment
\$21.95

SKIRT MARKER
with chalk **\$34.95**
w/o chalk **\$22.95**



Heavier squeeze tabs. Chalks marks will not rub off.



Chalk Refills page 19



Extensively Illustrated with step-by-step images for the professional.
\$39.95

Seams the Easy Way
Illustrated Instructive
\$39.00



PIN HEM MARKER
\$24.00



SNAP FASTENER TOOLS, GRIPPER SNAP TRAYS



PROFESSIONAL SNAP FASTENER MACHINE

Heavy Duty table-mount in Quality Steel at a very affordable price. Imported.
1 set of Dies included 20L or 24L
\$299.00

EXTRA DIES
16L, 18L
Gripper Snap Dies
\$94.95 each

Button covering Dies also available

PRESS-N-SNAP

Good snap repair tool, cast aluminum with 1 set of dies (Heavy Duty or Reg. with 1 set of dies (Spring snap or western Regular dies only Heavy Duty dies only Western dies only Dies for spring snaps (specify brand)

\$175.00
\$182.00
\$98.00
\$98.00
\$109.00

Optional Benchmount CL000100

\$25.50

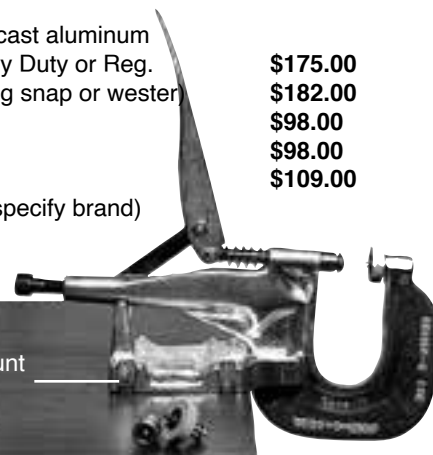

REGULAR JACKET SNAP TRAY 20L \$41.75



Gold, Silver or Antique. Nickel & Bronze combinations. Also white, black, navy, red. 20L ONLY

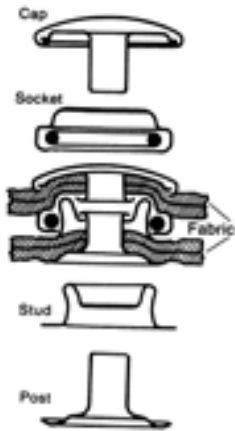

OSBORNE SNAP SET KIT

for jacket & jean snaps only
Tools with 25 silver snaps 24L or 20L
\$39.95



GRIPPER SNAP TRAY \$39.95

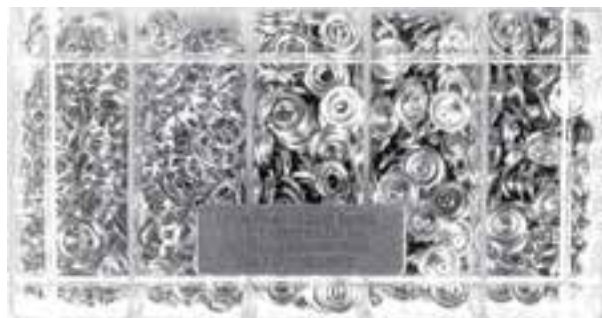

Gold 16L or 18L Silver 16L only

SPRING SNAPS

Antique Gold, Antique Silver, 24L or Silver, 20L
Tray of 100 sets each or assorted **\$42.95**

Dies for Spring Snaps available for PRESS-N-SNAP too

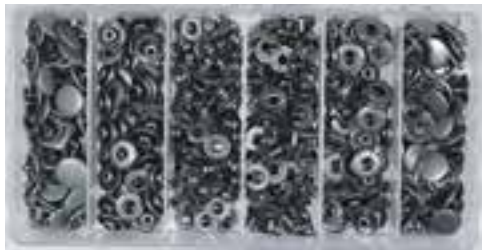

HEAVY DUTY JACKET & JEAN SNAPS 24L / 20L

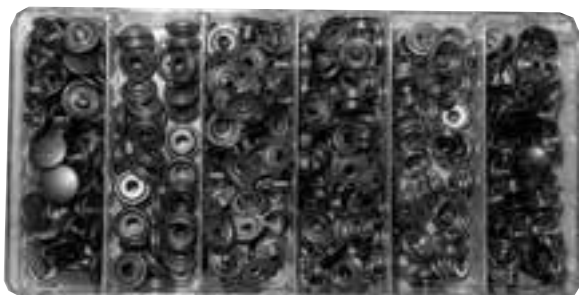

Heavy Duty. Gold, Silver or Antique. Nickel & Bronze combinations. Also white, black, navy.

Gold or Silver
\$36.95 each

Gold or Silver Tray
\$36.95

Antique Silver or Antique Gold
\$39.95

Colors
\$41.75
Specify Please

WESTERN SHIRT SNAP TRAY Black & White \$49.95

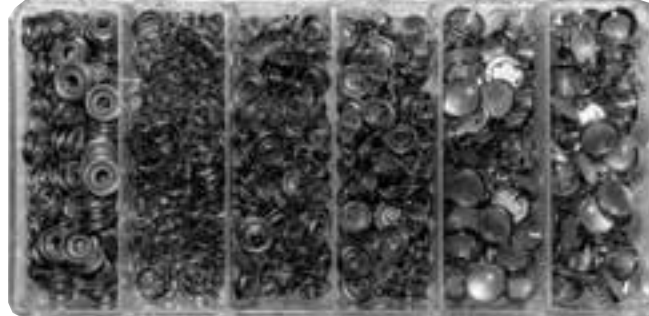

16L
18L White **ONLY \$49.95**

MARKING AIDS



TACH-IT® Model #3510

Hand-Held Twist Tie Machine

Fully portable and extremely lightweight, the Tach-It Model #3510 Hand-Held Twist Tie Machine can go where ever it's needed. Unlike stationary twist tie machines, Model #3510 can be used anywhere. It will bundle hangers together for the laundry and dry cleaners up to 1- 3/8" in diameter. This versatile unit has a fully accessible extended front tying aperture, an easy squeeze trigger, and an LED indicator to show battery life and the number of twists which is adjustable by the push of a button. Ribbon spool changes are quick and easy.



\$1,595.00

Refills for #3570, 5 spools per case \$47.00

Specifications

- 14"L x 9.5"W x 2.5"H
- Wt. - 3lbs. approximate
- Lithium polymer battery/ charging time 1.5 hrs.
- Usage - approximately 4,500 ties per charge
- Tying capacity - 3/8" to 1 3/8"

Kit Includes

- Model #3510 twist tie machine
- 2 battery packs / 110-260V AC battery charger
- Shoulder strap / Carry Case
- Protective enclosure for ribbon spool
- Instruction Manual

TACH-IT®



**#3567
\$1,795.00**

Internationally recognized as the most reliable semi-automatic, twist tie machine in the industry. Uses only a 3 inch piece of twist tie per closure which is 25% less that competitive machines. Holds 3 to 4 hangers together at the neck.

Dimensions: Length-21", Width-7", Height-12", Weight-16lbs.

Tying Capacity: 1/2" diameter and operating speed of 50 per minute

Power: 110 Volt (220 available)

FINE FABRIC™ SWIFTACH® SYSTEMS

The system to use for tagging fine non-wovens and delicate fabrics.

Mark II® Fine Fabric Plus®
Pistol Tool #10312

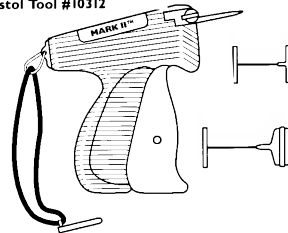

**Tagging Gun
\$34.95**

FINE FABRIC FASTENERS #10696



\$15.95 per box case of 10 \$149.00

10,000 per box. For dry cleaning and laundry. Tested to prevent jamming of guns in high humidity conditions.

REFILL SPOOLS fit TACH-IT & PLASTIES

Tach-it #3567

2500ft per spool
**10 per case \$209.95
each \$23.95**

Plasties HD-58



Ballpoint Laundry Pen



1 doz. **\$12.95**

DENNISON GUN NEEDLES



**Fine Fabric Needles
Plastic Shank
1-4 packs @ \$6.35**

**Metal (Mark II)
1-4 packs @ \$8.49**

BRASS SAFETY PINS

- 00 1 box **\$22.95**
 - 0 1 box **\$28.95**
 - 1 1 box **\$37.95**
- size 00
size 0

NICKEL PLATED

- size 1 **\$9.95**
- size 2 **\$16.25**
- size 3 **\$22.95**

T-PINS

- #20 **\$12.55**
- #24 **\$8.39**
- #28 **\$8.39**
- #32 **\$8.39**

TWIST-TIES 4" OR 7" GREEN

White or Striped available by the case



Case of 25 boxes
4" \$89.00

Case of 25 boxes
7" \$149.00

ADJUSTABLE SKIRT CLIP

Use with one hand. For thin & heavy garments.

Box of 1000 **\$34.50**
Box of 6000 **\$77.00**



**WHITE CLIPS
per 1000 \$4.25**



**ALUMINUM
SKIRT CLIPS**
Wide or Narrow
1000 **\$6.95**

Your shirt finishers will love this tool to button the collars on shirts and prevent sore fingers

SHIRT COLLAR BUTTONER \$3.95



HANGERS, DIVIDERS, BREATHABLE ZIPPERED BAGS, POLLY ROLL

CONTOUR HANGERS

Men's suit hangers molded plastic with wooden pant bar
\$129.00 - 100 per box
 Broad head and shoulder area for better garment support



WOODEN CONTOUR HANGERS

\$199.50 - 100 per box

STRUT HANGERS

Wire hangers with tubes, 16"
\$99.95 - 500 per box

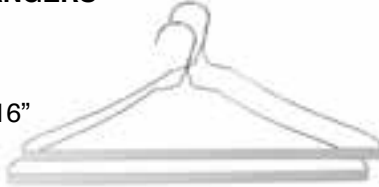

AlbaChem® Hold Tight Adhesive

- Great for Strut Hangers
- Fast Tack
- Ability to Reposition
- Temporary or Permanent Bond
- Pressure Sensitive
- Will not Transfer

Mist Spray Pattern

For all uses ... Cloth, Foam, Plastic, Film, Wood and Cardboard
 each **\$8.59** 1 dozen **\$99.00**

2 lb. can

MAGIC SLEEVE

HOW TO USE MAGIC SLEEVE

Please read carefully before using the MAGIC SLEEVE.

1. Make sure you look at the picture carefully.
2. Make sure you are holding the right side up (narrow side is for you to hold on to and wide side should be facing up).
3. When you put a MAGIC SLEEVE into the jacket's sleeve make sure about 1/3 of sponge is showing from edge of the sleeve.

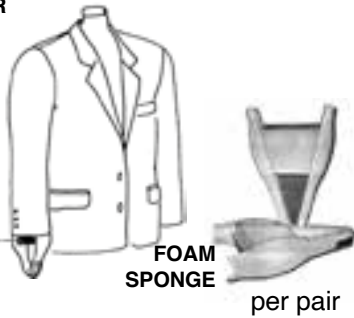

FOAM SPONGE

per pair

Small **\$35.95** Med. **\$37.95** Large **\$39.95**

RACK DIVIDERS



ROUND

BLANK 100 for **\$31.00**

A-Z **\$18.50**

Mon-Sat **\$10.25**

1-31 **\$21.95**

OBLONG

BLANK each **\$1.09**

A-Z **\$33.95**

HEAT SEAL BAGGING MACHINE

POLY AVAILABLE FOR ALL MAKES AND MODELS!!
 PLEASE SPECIFY!

Call for current prices

VINYL ZIPPERED BAGS

VINYL ZIPPERED BAGS



Suit bags 40" 1 dozen **\$29.95**
 100 **\$249.00**

Dress Bags 54" 1 dozen **\$39.95**
 100 **\$279.00**

Imprinted with you LOGO

40" 100 **\$249.00**

54" 100 **\$279.00**

Breathable, Zippered Suit Bags (Black)

40" 1 dozen **\$33.50**

50 **\$129.00**

Breathable, Zippered Dress Bags (Black)

54" 1 dozen **\$43.50**

50 **\$169.00**

Imprinted, Breathable, Suit Bags

40" 100 **\$220.00**

Imprinted, Breathable, Dress Bags

54" 100 **\$279.00**

BRIDAL COVERS, ZIPPERED WITH GUSSETS

CLEAR PLASTIC, 72", 1 dozen **\$54.00**

WHITE VINYL, 72", 1 dozen **\$52.00**

BREATHABLE, 72", 1 dozen **\$69.00**

50 **\$269.00**

IMPRINTED BREATHABLE BAGS

72", 100 **\$495.50**



POLY ROLL

Clear, Perforated, 0006 Gauge, 1563ft 21"wide 9" gusset

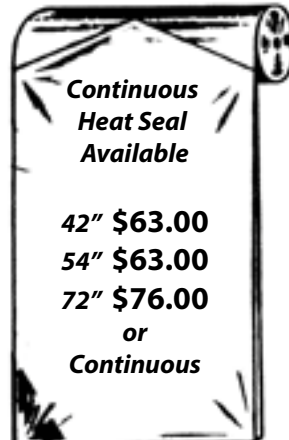

Continuous Heat Seal Available

42" **\$63.00**

54" **\$63.00**

72" **\$76.00**

or

Continuous

BREATHABLE BLANKET BAGS

15" x 18" x 3" Carton of 12 **\$79.95**



Custom Imprinted with your LOGO

Minimum 720 **\$1179.00**

MENDING TAPES, PATCHES, TABS, Ez-PRESS, LABELALL₃™

REFLECTIVE TAPE - 3M

1" Silver, 200m	\$219.00	6 each \$199.00
2" Silver, 200m	\$399.00	6 each \$349.00
FLAME RETARDENT		
1" Silver, 100m	\$229.00	6 each \$205.00
2" Silver, 100m	\$469.00	6 each \$430.00
GROGRAIN		
1½" Lime with ½" Silver reflective line		100 yd \$99.00

IRON-ON TAPE - Rolls



Black, White, Navy, Brown, Postman Blue,
Tan, Beige, Grey, Lt. Blue

3" X10 yds. roll **\$18.50**

PATCHIT™

**THERMO PLASTIC
MENDING KIT
\$57.00**

12 rolls each 3" X 72"

No fr patches in this kit



Quality Systems for Textile Heat Sealing, Decorating and Mending

Digital PopUpPress® & EZPress® apply labels & patches in 7 seconds!

- **Apply barcode & text labels from all manufactures**
TrackIt™, EzLabels™, Computype labels & Thermanpatch labels.
- **Reliable computerized time & temperature control**
The digital computer is calibrated to within 1° accuracy and will hold platen temperature to within 2° of your pre-set value.
- **Operator error alert**
The digital computer will alert the operator if he/she applies a label when the platen is too hot or too cold or if he/she lifts the handle before the pre-set application time has elapsed.
- **Encrypted setup prevents operator tampering**
The time and temperature setup and calibration can be changed only by a technician who knows the encrypted access code.
- **Automatic fabric thickness adjustment**
Lower Platen automatically adjusts for thick and thin garments. Label a silk blouse, then a winter coat with no adjustments.
- **Prices**
EzPress®, 115V with 15" (3"x5") platen part number **EZP-DIG15-115 \$995.00**
PopUpPress®, 115V with 15" (3"x5") platen part number **PUP-DIG-5-115 \$1,395.00**



Digital PopUpPress™
PUP-DIG-15 with 3"x5" platen

The **Digital PopUp Press®** is automatic; handle and heated platen will pop up when the application cycle is complete.

The **EZPress®** is a manual press; a buzzer will sound when the application cycle is complete and the operator must lift the handle to open the heated platen.

Print Permanent Clothing Labels



**Portable notebook sized
label printer**

Runs on batteries or AC power.

LabelAll3™ \$149.00

Cartridges \$31.95

HEAT SEAL MENDING

TAPE ROLLS

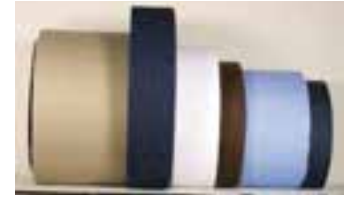

50 YARD ROLLS

Size	Percale or Twill	Percale or Twill
1" x 50 yd.	\$30.95	50 + yds. \$29.50
2" x 50 yd.	\$48.95	50 + yds. \$46.50
3" x 50 yd.	\$69.95	50 + yds. \$66.50
4" x 50 yd.	\$93.95	50 + yds. \$88.95

HEAT SEAL TEXTILE TAPE

COLOR CHART PAGE 29

PRE-CUT MATERIAL:	Qty.	Minimum	PRICE PER 1000
Stock Sizes	Per Box	Order	Percale/Twill
½" X ½"	4M	4M	\$15.25
¾" X ¾"	2M	2M	\$16.50
¾" X 2"	1M	1M	\$28.00
¾" X 3"	1M	1M	\$37.95
1" X 1"	2M	2M	\$25.25
1½" X 1½"	1M	1M	\$43.75
1½" X 3"	500	1M	\$66.00
2" X 2"	500	1M	\$64.50
3" X 3"	500	500	\$123.00
4" X 4"	500	500	\$199.00

ASSORTED MENDING KIT

COLOR CHART \$59.00



PLEASE CALL FOR PRICES

BULK SPOOLS	PRE-CUT PATCHES	PRE-CUT PATCHES
Sold in 50 Yard Rolls	Round or Square	Rectangle
1" x 50 yards	1/2" (4 M*)	3/4" x 2" (1M*)
1-1/4" x 50 yards	3/4" (2M*)	3/4" x 3" (1M*)
2" x 50 yards	1" (2M*)	1-1/2" x 3" (500*)
3" x 50 yards	1-1/2" (1M*)	2-1/2" x 4" (500*)
4" x 50 yards	2" (500*)	4" x 6" (500*)
	3" (500*)	
	4" (500*)	

6000 2" patches **\$56.25**, 3" round patches **\$108.00**, 50 yd. roll 2" **\$42.20**

PATCHIT® TEXTILE PATCHING MATERIAL

PATCHIT® PERCALE

1 White	2 Black	3 Med Gray	4 Dark Gray	5 Brown	6 Khaki	7 Navy Blue	8 Beige	9 Light Blue
10 Powder Blue	11 Cranberry	12 Yellow	13 Pink	14 Olive	15 Light Gray	16 Royal Blue	19 Jade	20 Misty Green
22A Fatigue Green	31 Spruce	32 Orange	36 Postman Blue	50 Red	51 Burgundy	52 Lilac	53 Oxford Blue	55 Charcoal

PATCHIT® TWILL & FIRE RETARDANT (FR) Please indicate FR when placing order.

17 White	18 UB Drill	22 Spruce	23 Army Tan	24 Med Gray	26* Navy	27 Postman Blue	28* Denim Blue	29 Fisher	
30* Med Blue	33 Brown	34* Dark Gray	35* Orange	37* Visual Green	38* Visual Yellow	39* Hunter Green	40* Khaki	41* Red	
42* Royal Blue	43* Light Gray	45* Black	PATCHIT®FR™ Flame Retardant Fabric: Cotton ASTM F1506, NFPA70E HRC/2, NFPA 701, and OSHA 29 CFR 1910.269 * Available in Twill or Fire Retardant. Please indicate FR when placing order.						

MEDICAL BARRIER FABRIC - MAXIMA 100% POLYESTER

Contamination Control

60 Eyereast Green	61 Yellow	62 Ceil Blue	63 White	64 Cloud Blue
----------------------	--------------	-----------------	-------------	------------------

MEDICAL BARRIER FABRIC - RESISTAT 99% POLYESTER • 1% CARBON

Contamination Control

70 Eyereast Green	71 Jade Green	72 Ceil Blue	73 White	74 Navy	75 Black
----------------------	------------------	-----------------	-------------	------------	-------------

Actual product color may vary.

WWW.LUCASQUALITYPRODUCTS.COM • 419.277.0725 • SALES@LUCASQUALITYPRODUCTS.COM



Proudly made in the USA.

DRESS AND SPORT SHIRT BUTTONS

EMSIG SUPERDURABLE® PEARLIKE SHIRT BUTTONS

LIEBERMAN EXCLUSIVE
ASSORTED SUPERDURABLE STYLES
White and Cream 18L and 14L **\$44.95**



Superdurable reorder card with purchase

SUPERDURABLE® SPECKLED TRAYS
Assorted sizes **\$44.95**



ARAN TRAY BASIC

Assorted sizes, white, natural, smoked

Extra Thick
\$39.95
\$10.95 per gross



Extra Thick **ARAN TRAY COLORS**
Assorted 18L and 14L **\$44.95**



Our most popular buttons are favored by most customers.
4 gross each size
\$26.50

TAYLOR

18L 16L 14L



KNIGHT

18L 14L



JC PENNY SMOKE

18L 16L 14L



JC PENNY CREAM

18L 16L 14L



NEW LANDS END

17L 15L 13L



CLASSIC SQUARE BUTTON TRAY

18L, 6 Colors **\$44.95**



ETON BUTTON TRAY

2 HOLE, 14L and 18L
Black, Brown, Navy, Pearl

\$39.95

Extra Thick



CHALK BUTTON TRAYS

Our very popular color assortment of dull chalk shirt-blouse buttons in 14L or 18L.
Available in assorted color trays
White by the gross. **\$49.95**



SPRINGFIELD HIPPOCKET TRAY

\$49.95



NIAGARA TWIN

20L Uniform Tray **\$44.95**



AIL-PEARLIKE 4 HOLE TRAYS

Assorted colors in each size 22L, 20L, 18L, 14L
14L or 18L **\$44.95** 20L or 22L **\$49.95**



AIL-PEARLIKE 2 HOLE

Cup shaped, white, smoked 13L, 15L, 17L, 19L, 21L, 23L
23L used for hippockets

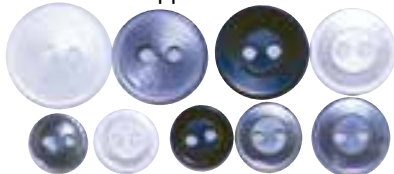

2 HOLE OR 4 HOLE
5 gross boxes in smoked,
white and individual colors.

SMOKED/WHITE		COLORS	
13L-17L	\$12.95	13L-17L	\$24.95
19L	\$14.50	19L	\$25.95
21L-23L	\$15.00	21L-23L	\$27.95

UNIFORM, WORKSHIRT & TROUSER BUTTONS

SHIRT BUTTONS

NIAGARA TWIN 20L

1 greatgross per color **\$48.50**

4703 Black	8104 White	4102 Lt. Grey	4407 Med. Grey
4723 Charcoal	2139 Tan	2138 Putty	2712 Brown
5403 Wine	9711 Orange	9129 Yellow	9134 Yellow
1584 Blue	1108 Blue	3110 Green	3707 Spruce
1709 Navy	1405 Twill	1433 Blue	1707 Royal



PANTS BUTTON

INDUSTRO 22L

1 greatgross per color **\$49.50**

Black, Dark Beige, Dark Brown, Dark Green, Navy, Graphite, Medium Grey



PANTS BUTTONS

YUKON 22L

1 greatgross per color
1709 navy, 8104 white, 4703 black,



\$49.50

SUSPENDER BUTTONS 27L

Black & White
1 gross per color **\$5.95**



CHRIS HIPPOCKET 24L

1 gross per color
18L **\$7.95** 24L **\$10.95**



CHRIS

Polished 18L, 3 gross box in colors

2634 2293 2205

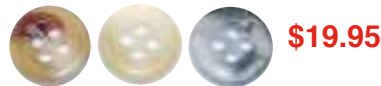

\$19.95

CHRIS TRAY

24L and 18L 3 shades **\$44.95**



QUARTERBALL / LABCOAT BUTTONS

White 2 hole and 4 hole Color
30L **\$7.00** per 1 gross 30L **\$8.00**
24L **\$6.50** 24L **\$6.95**



CASUAL BUTTON 30L, 24L

White per 1 gross Color
30L **\$10.95** 30L **\$11.95**
24L **\$8.40** 24L **\$9.50**



RINGFISHEYE

per 1 gross
smoked or white
45L 30L 24L 19L 17L 15L



19L **\$5.75**
24L **\$8.95**
30L **\$9.98**

UNIFORM DRESS SHIRT

18L or 14L 5 gross **\$32.95**
Dark Horn, Horn, Brown, Dark Grey,
Off White, Black, Cedar



UNIFORM DRESS SHIRT

19L or 3 gross **\$26.95**
Long Horn, Horn Brown, Rock Horn,
Light Tan, Black, Cedar



BUTTONS FOR SUITS, SPORTSCOATS, & OVERCOATS

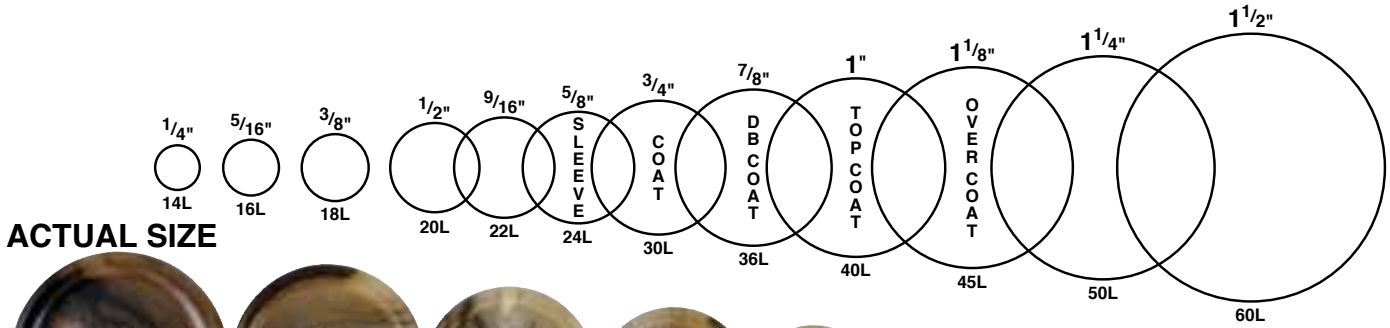

ACTUAL SIZE



45L

40L

36L

30L

24L

COMO BUTTONS (SHINY OR DULL)

LORI STANDARD SUIT BUTTON

LORI 36L
\$28.95 per gross
\$2.95 dz

RAINCOAT AND TOPCOAT BUTTONS

Como Shiny 1/2 Gross	Lori Dull 1/2 Gross
45L \$25.95	45L \$27.95
40L \$20.95	40L \$22.95

Light Alden, Rock Horn, Black London Fog, Dark Tan, Dark Grey

COMO ECON TRAY \$34.95

By the gross 24L **\$20.50**, 30L **\$22.95**

Dk. brown	Camel	Lt. grey	M. grey
Black	Navy	LondonFog	Covert grey
Rockhorn	White	Dk. tan	Dk grey

LORI ECON TRAY \$39.95

By the gross 24L **\$21.75**, 32L **\$24.95**

Black	Navy	M. blue	Dk. brown
M. brown	Dk. tan	Lt. beige	Rust
Lt. grey	Dk. grey	Olive	Horn



LOUIS SUIT BUTTON

Narrow rim, by 1/2 the gross

24L \$14.95 30L \$17.95

Olive, Black, Light Grey, Dark Gray, Khaki, Navy



FATIGUE BUTTONS

By the gross 30L **\$10.95**

Navy, Tan, Black, Grey, OD, Foliage

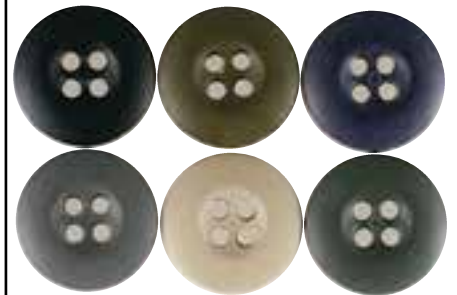

COMO, DULL 24L, HIPPOCKET

1 gross per color **\$20.50** 32L **\$22.95**

D. Brown	Navy	Camel	L.Grey	M.Grey	Black
Rock Horn	D. Tan	White	D. Grey	London Fog	Lt. Alden



NUTZ 32L, 24L

Md. brown, Dk. brown

24L **\$11.95**

32L **\$14.95**



CORNERSTONE TRAY

30L and 24L

\$49.95



By the gross 30L **\$24.95**, 24L **\$21.75**

Ivory Khaki Deep Brown



Navy Deep Grey Black

TOMMY BAHAMA TRAY

Assortment of 20L, 24L, 28L **\$44.95**

Dull or Shiny per gross

20 L \$10.95 24 L \$13.95 28L \$17.95



FRESHWATER PEARL, ABALONE & SHELL BUTTONS

FRESHWATER PEARL TROCHA 2 HOLE

No rim, 2 hole, white, smoked per 1 dozen

36L \$17.90 30L \$10.95 24L \$6.50 20L \$5.95 18L \$5.70



FRESHWATER PEARL TROCHA 4 HOLE

Flat rim, 4 hole, white, smoked per 1 dozen

40L \$26.50 36L \$17.90 30L \$10.95
24L \$6.60 20L \$5.95 18L, 16L & 14L \$4.95



POLO TROCHA

Beveled rim, white, smoked per 1 dozen

20L \$5.95 18L, 16L & 14L \$5.70



SHELL TRAY ASSORTED

Natural, Smoked, Lt. Blue, Dk. Brown

\$47.95



MUSSEL BUTTONS

blue or brown

1dozen 36L \$6.75, 28L \$4.20
2dozen 18L \$4.10, 20L \$5.00, 24L \$6.00

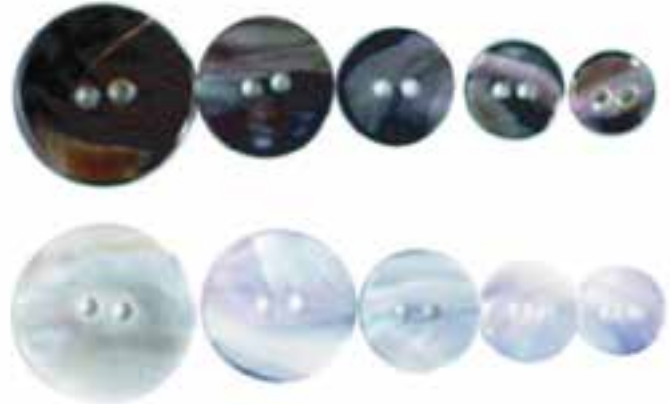

ABALONE

light or smoke

1dozen 45L \$5.20, 40L \$4.45, 36L \$3.75, 28L \$2.75
2dozen 24L \$4.50, 20L \$3.50, 18L \$2.50

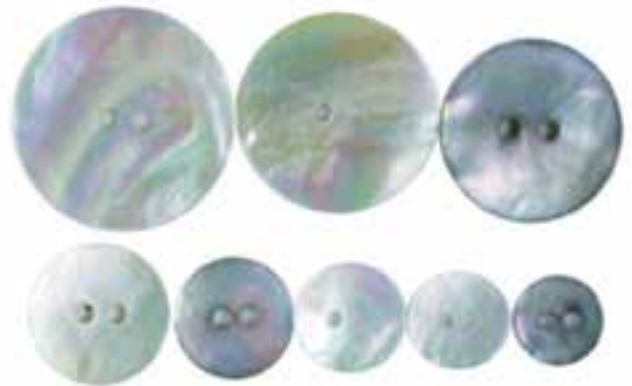

ABALONE TRAY LIGHT

40L, 36L, 30L, 24L, 22L, 18L contains all sizes
\$39.95



ABALONE TRAY SMOKE

40L, 36L, 30L, 24L, 22L, 18L contains all sizes
\$42.95



BLAZER, IMITATION PEARL, TUXEDO, BRIDAL, LEATHER, DISK, BUCKLES

BLAZER BUTTON TRAY

30L, 24L **\$49.50**



CLASSIC BLAZER BUTTONS

by the dozen or gross
Plain, Old Shield, Circles, Crest

36L **\$5.95** doz. 30L **\$4.40** doz. 24L **\$3.65** doz.



NEW BLAZER BUTTONS

by the dozen or gross

53 40 41 31



49 267 5184 138/63
32L **\$7.65** doz. 24L **\$5.25** doz.

NEW BLAZER TRAY \$65.95

BAND BUTTONS

Stripe or Lyre - by the dozen or gross
36L **\$12.25** 30L **\$11.50** 24L **\$10.25**



DOME

brushed or shiny
36L **\$10.95** 30L **\$8.50** 24L **\$7.25**



IMITATION PEARL "MAJORCA"

by the gross
smoke, white, natural, tan
30L **\$23.95** 24L **\$19.95** 36L **\$24.95**



IMITATION PEARL "EMILY"

2 hole by the gross, natural
18L **\$5.45** 20L **\$6.95** 24L **\$13.95**
30L **\$15.95** 36L **\$24.95**

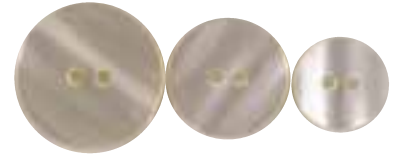

DISK TRANSPARENT

2 hole or 4 hole by the gross
36L **\$8.49** 30L **\$5.95**
24L **\$5.95** 19L **\$4.95**
17L **\$3.95**



BRIDAL BUTTONS SATIN

by the gross 18L
white, ecru, black,
dome, cloth back
\$27.95



24L 18L 18L

TUXEDO BUTTONS



By the gross, white, black
dome, flat, metal shank
satin or gros grain

36L **\$34.95**
30L **\$32.95**
24L **\$31.95**

LEATHER NUBS

by the dozen

Natural Black Lt. Brown Dk. Brown Tan



40L **\$7.50**
36L **\$4.95**
30L **\$4.25**
24L **\$3.95**

BOW TIE & VEST HARDWARE

\$11.95 doz.



BLOUSE SPRING HOOKS

\$2.95 doz.



CUMMERBUND HARDWARE

\$4.95 doz.



OVERALL BUCKLES

by the dozen pair
Antique **\$26.95**



SABA "C" Thread Chart

Numerical Index of
Colors Page 66

All 500 colors stocked in 1000 meter tubes, size 100

Cones, #100, 5,000m = O

Spools, #30, 300m = X

1			2			3			4			5		
2002	O		1130	X		600	.		1167	.		65	X	
2000	O		1504	X		5099	.		1401	X		1063	.	
1000	O		891			511	.		1176			1057		
778	O		782	O		60			1334	.		638		
	X			X		81				X		155		
776			892			5019	.		451			156	.	
5018	.		121			134	O		450	.		1066		
	X		5021	.			X		1458			1060		
1161	X		2260	.		78	.		1336			867		
3000	O		122			633	X		790			1411		
	X		147			637			501			628		
528			1163	X		622			104	.		1402	O	
1384			1168			135	.		503	O		89		
129	O		1507			137			2239			448		
	X		177			1073			504	.		1391		
781	O		174			1288			630	X		629		
	.		1131	.		507			105	.		1392	.	
1209			178	X		1074	O		98	X		869		
780			897	X		636			508	.		106	.	
1454			899	.		1055			642			918	.	
140	X		277	X		1347			203			871		
141	X		163	.		1054			1348	.		639		
114	.		278	.		1346			128			204		
115	.			X		196			166			109	.	
1102	X		262	X		1353			1349			111	O	
3361	.		900	X		296			1350				X	
113			1320											
120	.													
607	O													
	.													
118														

SABA "C" Thread Chart

Numerical Index of
Colors Page 66

All 500 colors stocked in 1,000 meter tubes, size 100
Cones, #100, 5,000m = O
Spools, #30, 300m = X

6			7			8			9			10		
5096	.		2138			84			23	O		1081		
82	.		1059			63			381			42		
1056	.		1062	.		88			37	.	X	1342		
5098	.		56			27	.		36			350	O	.
67	X		575	X		572			363			1363	O	.
1429	.		57			9	.		271	O	.	12		
1438			52	.		1079			362			1137		
1421	.	X	87			1253			814	.		309	X	
1423	.		602			1379	.		357			392	.	
1417	.		35	.		1370			356			923		
1418			569			1085			818	.		1275	X	
471			55	X		577			819			1316		
157	.		3040	.		1078	.		1368			698		
1067			1490			13	.		1464			311	O	.
108			570			579	.		1315			307	X	
158	.		30			586			815	.	X	585	X	
162	.		3585	.		16	.		2255	.		1276		
799	X		46	O	X	580			1303	.		792		
793	.		578	.		787			1304	.		805	.	X
153	O	X	473			796			816	.		829		
284	.		160			482	.	X	823	.	X	827	.	
433			477			478			1305	O		821	O	X
282			476			1374			809			822	O	.
295			300			298			825	.	X	954	.	
167			305	X		479			5068	.		1254	.	X

SABA "C" Thread Chart

Numerical Index of
Colors Page 66

All 500 colors stocked in 1,000 meter tubes, size 100
Cones, #100, 5,000m = O Spools, #30, 300m = X

11			12			13			14			15		
812			237			71	.		842	x		1212		
5050	.		1338			91			1210			529		
272			18	.		1095	.		882			727	x	
273			406	.		219			840			651		
21			1090	.		236			839			652		
338			230	.		251			92	.		650	.	
22			229	O X		1099	.		1098			404	x	
337	.		20	.		8507			255			649		
999			1410			1620	.		1343			731	.	
692	x		6			224	.		1337			732		
24			1214	O		239	.		1345			730		
1306			611			909	.		1412	O		663	O X	
806			1440	.		247			1351			554	.	
807	x		1091	.		222			1309			719	.	
485			232			240			1147	x		664	O	
763	x		760			757	.		1148	.		625		
5094	.		359			1203			665			1213	O X	
408	.		1216	O .		1202			466			5016	.	
998			314	x		646	x		1103			530	.	
616			759	O .		1097	.		243			1185		
409	.		425			216			666			373	x	
2126			949	x		627			420			381		
1394	.		950	.		846			660	O		1162	x	
722	x		943	x		2540			667	x		1043	.	
483			944			426	x		464			523	x	

SABA "C" Thread Chart

Numerical Index of
Colors Page 66

All 500 colors stocked in 1,000 meter tubes, size 100

Cones, #100, 5,000m = O

Spools, #30, 300m = X

16		17		18		19		20		21	
182	· X	779	O · X	770		412	· X	38	·	1426	
1312		5095	·	327	·	413		411	O ·	70514	
1311	X	260	O X	672		962		331	O · X	2730	
1207	X	828		861		322	X	321	X	7137	
858		512	·	326	O · X	1358		1140	·	1427	
290	X	280	X	372	·	414		340	O	8083	
865		281	X	537	O X	2131		318	·	1428	
890		387		538	X	1239	O · X	323	X	7888	
1385	·	1223	· X	1222	O ·	1180	X	332	· X	2643	
671		263	O X	379	·	1177	O ·	415	O · X	8775	
265	X	975	X	380	X	402		1360	X	7801	
1117	O · X	1380	O	475	·	1340		416	O · X	70684	
285		833		268	· X	850		1238		70087	
1120	·	264	· X	269	X	851		348	· X	7089	
291		428	·	1183	·	852		1361	O ·		
1121	X	395	· X	1133	O X	853		1282	O X		
261		432		397		1138		1283	O · X		
287	X	2193		1182	· X	333	O · X	1237			
267	· X	1227	· X	1134	O X	343		1362	O X		
1160		1228	O	1048	· X	878	· X	1287	X		
465		398		1382	X	345	X	4000	O · X		
971		399		1002	X	1242	X	4004			
1424	O ·	329	·	431	O X	1284	O X				
1425		1235		1175	O X	1008					
565	·	324	O	1050	·	2344					

saba

Farbnummern-Verzeichnis · Numerical Index of Colours

Farbe Colour	Spalte Column	Farbe Colour	Spalte Column	Farbe Colour	Spalte Column	Farbe Colour	Spalte Column	Farbe Colour	Spalte Column	Farbe Colour	Spalte Column	Farbe Colour	Spalte Column	Farbe Colour	Spalte Column	Farbe Colour	Spalte Column	Farbe Colour	Spalte Column
6	12	134	3	278	2	398	17	569	7	760	12	892	2	1131	2	1306	11	1428	21
9	8	135	3	280	17	399	17	570	7	763	11	897	2	1133	18	1309	14	1429	6
13	8	137	3	281	17	402	19	572	8	770	18	899	2	1134	18	1311	16	1438	6
16	8	140	1	282	6	404	13	575	7	776	1	902	2	1137	10	1312	16	1440	12
17	10	141	1	284	6	406	12	577	8	778	1	909	13	1138	19	1315	9	1454	1
18	12	147	2	285	16	408	11	578	7	779	17	918	5	1140	20	1316	10	1458	4
20	12	153	6	287	16	409	11	579	8	780	1	923	10	1147	14	1320	2	1464	9
21	11	155	5	290	16	411	20	580	6	781	1	943	12	1148	14	1334	4	1490	7
22	11	156	5	291	16	412	19	585	10	782	2	944	12	1160	16	1336	4	1504	2
23	9	157	6	293	6	413	19	586	8	787	8	949	12	1161	1	1337	14	1507	2
24	11	158	6	296	3	414	19	600	3	790	4	950	12	1162	15	1338	12	1620	13
27	8	160	7	298	8	415	20	602	7	792	10	954	10	1163	2	1340	19	2000	1
30	7	162	6	300	7	416	20	604	3	793	6	962	19	1167	4	1342	10	2002	1
35	7	163	2	305	7	420	14	607	1	796	8	971	16	1168	2	1343	14	2126	11
36	9	166	4	307	10	425	12	611	12	799	6	975	17	1175	18	1345	14	2131	19
37	9	167	6	309	10	426	13	616	11	805	10	998	11	1176	4	1346	3	2138	7
38	20	174	2	311	10	428	17	622	3	806	11	999	11	1177	19	1347	3	2193	17
42	10	177	2	314	12	431	18	625	15	807	11	1000	1	1180	19	1348	4	2239	4
46	7	178	2	318	20	432	17	627	13	809	9	1002	18	1182	18	1349	4	2255	9
52	7	182	16	321	20	433	6	628	3	812	11	1006	19	1183	18	1350	4	2260	2
55	7	196	3	322	19	448	5	629	5	814	9	1043	15	1185	15	1351	14	2344	19
56	7	203	4	323	20	450	4	630	4	815	9	1048	18	1202	13	1353	3	2540	13
57	7	204	5	324	17	451	4	633	3	816	9	1050	18	1203	13	1358	19	2643	21
63	8	216	13	326	18	464	14	636	3	818	9	1054	3	1207	16	1360	20	2730	21
65	5	219	13	327	18	465	16	637	3	819	9	1055	3	1209	1	1361	20	3000	1
67	6	222	13	329	17	466	14	638	5	821	0	1056	6	1210	14	1362	20	3040	7
71	13	224	13	331	20	471	6	639	5	822	10	1057	5	1212	15	1363	10	3361	1
78	1	229	12	332	20	473	7	642	4	823	9	1059	7	1213	15	1368	9	3585	7
81	3	230	12	333	19	475	18	646	13	825	9	1060	5	1214	12	1370	8	4000	20
82	6	232	12	337	11	476	7	649	15	827	10	1062	7	1216	12	1374	8	4004	20
84	8	236	13	338	11	477	7	650	15	828	17	1063	5	1222	18	1379	8	5016	15
87	7	237	12	340	20	478	8	651	15	829	10	1066	5	1223	17	1380	17	5018	1
88	8	239	13	343	19	479	8	652	15	833	17	1067	6	1227	17	1382	18	5019	3
89	5	240	13	345	19	482	8	660	14	839	14	1073	3	1228	17	1384	1	5021	2
91	13	243	14	348	20	483	11	663	15	840	14	1074	3	1235	17	1385	16	5050	11
92	14	247	13	350	10	485	11	664	13	842	14	1076	8	1237	20	1391	5	5068	9
98	4	251	13	356	9	501	4	665	14	846	13	1079	8	1238	20	1392	5	5094	11
104	4	255	14	357	9	503	4	666	14	850	19	1081	10	1239	19	1394	11	5095	17
105	4	260	17	359	12	504	4	667	14	851	19	1085	8	1242	19	1401	4	5096	6
106	5	261	16	361	9	507	3	671	16	852	19	1090	12	1253	8	1402	5	5098	6
108	6	262	2	362	9	508	4	672	18	853	19	1091	12	1254	10	1410	12	5099	3
109	5	263	17	363	9	511	3	692	11	856	16	1095	13	1275	10	1411	5	7089	21
111	5	264	17	372	18	512	17	698	10	858	16	1097	13	1276	10	1412	14	7137	21
113	1	265	16	373	15	523	15	719	15	861	18	1098	14	1282	20	1417	6	7801	21
114	1	267	16	379	18	528	1	722	11	867	5	1099	13	1283	20	1418	6	7888	21
115	1	268	18	380	18	529	15	727	15	869	5	1102	1	1284	19	1421	6	8083	21
118	1	269	18	381	15	530	15	730	15	871	5	1103	14	1287	20	1423	6	8507	13
120	1	271	9	387	17	537	18	731	15	878	19	1117	16	1288	3	1424	16	8775	21
121	2	272	11	392	10	538	18	732	15	882	14	1120	16	1303	9	1425	16	70087	21
122	2	273	11	395	17	554	15	757	13	890	16	1121	16	1304	9	1426	21	70514	21
128	4	277	2	397	18	565	16	759	12	891	2	1130	2	1305	9	1427	21	70684	21
129	1																		

Rev. 2017

Farben liegen im Rahmen branchenüblicher Abweichungen · Colours may differ within usual trade standards

ZIPPERS

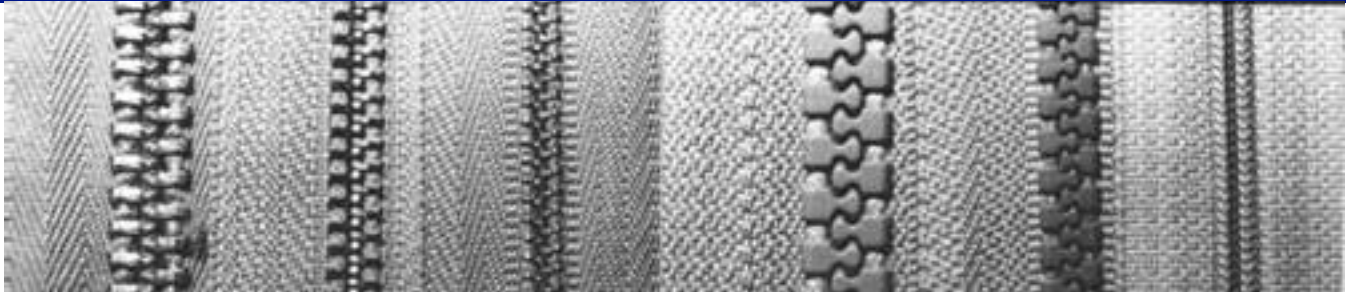

#10 METAL

#5 METAL

#3 METAL

#10 MOLDED PLASTIC

#5 MOLDED PLASTIC

#5 NYLON COIL

ALL PRICES PER DOZEN

YKK MOLDED VISLON JACKET ZIPPERS

#5 1- SLIDER

24"	\$18.50
26"	\$19.50
30"	\$22.50
36"	\$24.65
48"	\$3.10 each <i>Black only</i>
60"	\$6.10 each <i>Black only</i>

#5 2- SLIDER

26"	\$29.95
30"	\$32.50
36"	\$35.75
48"	\$4.55 each <i>Black only</i>

CHOOSE FROM COLORS BELOW



527	519	850	523	504	501	512	516	628	865	553	546	823	548																
Wine	527	Red	519	Rust	850	Orange	523	Yellow	504	White	501	Pink	512	H. Pink	516	Mauve	628	Purple	865	Orchid	553	Lavender	552 (not shown)	L. Blue	546	Mint	823	Turq	548



580	567	906	560	588	839	546	579	578	576	841	573	K007	564	569	570																			
Black	580	Olive	567	Teal	906	Navy	560	Royal	588	M. Blue	839	L. Blue	546	D. Grey	579	M. Grey	578	L. Grey	576	Natural	841	Beige	573	Camel	K007	Taupe	564	M. Brown	569	D. Brown	570	Kelly	826	(not shown)

#10 MOLDED 1-SLIDER

#3 MOLDED 1-SLIDER

Beige, Navy, Black Brown
24" \$16.50
30" \$20.50 black only

Black	Wine	White	Brown	<i>Black Only</i>
Red	Navy	Grey	L. Blue	
24" each \$3.60	30" each \$4.55	36" each \$5.25	60" each \$6.50	

#10 MOLDED 2-SLIDER

Black, White, Navy, Grey, Beige, Brown			
30" \$50.20	each \$4.55	36" \$56.15	each \$5.25

#8 MOLDED 1-SLIDER

36" \$47.95 Black Only
each \$4.35

48"	each \$5.50	60"	each \$6.75
-----	-------------	-----	-------------

#3 NYLON COIL ZIPPERS FOR PANTS, SKIRTS, DRESSES #3

PRICE PER DOZEN



9" \$4.25 dz.
22" \$8.45 dz.

CHOOSE COLORS FROM THREE STRIPS ABOVE

Price Per Dozen

24" \$8.75 dz.

Black 580	White 501	L. Grey 133	Natural 571	M. Brown 569	Green 830
Navy 560	Red 519	M. Grey 578	Beige 573	D. Brown 917	Teal 877
Royal 558	Pink 511	D. Grey 156	Taupe 544		

11" \$4.75 dz.

Black 580	D. Grey 156	Natural 571	Camel 007	D. Brown 917
Navy 560	M. Grey 578	L. Beige 572	Taupe 564	Wine 520
White 501	L. Grey 133	Beige 573		

7" \$3.75 dz.

Black 580	M. Blue 363	Teal 877	Wine 520	Orchid 552	Peach 522
Navy 560	L. Blue 546	Mint 532	Red 519	Lavender 553	Yellow 089
Royal 558	Aqua 548	L. Grey 133	White 501	Natural 571	Camel 007
D. Grey 156	M. Grey 578	Beige 573	Gold 506	L. Beige 572	Taupe 564
M. Brown 569	D. Green 830	Olive 566	Pink 511	Fuchsia 853	

YKK NYLON COIL SEPARATORS

PRICE PER DOZEN

#3 1- SLIDER

24" **\$23.95**
Black, Natural, Navy, Red
White, Brown, D. Grey, Taupe
28" **\$27.95**
Black, White, Natural, Navy, D. Grey

#4.5 POLICE SHIRT SEPARATORS 1 SLIDER

Black, Navy, Beige, Postman Blue,
White, Grey, Brown, L. Blue
14" **\$18.25** 16" **\$18.60**

#4.5 SEPARATORS 1 SLIDER

Black, Natural, D. Brown, Taupe, Teal
White, Navy, Beige, Grey, Red, Dk. Brown
24" **\$20.95** 28" **\$23.50**

#5 JACKET COIL 1-SLIDER

Black, Natural, Taupe, White, Navy, Beige, Grey
24" **\$18.70** 30" **\$22.95** (36" **\$26.00** Navy & Black)
30" also Lt., Med., Dk. Grey

#3 JACKET COIL 2-SLIDER

Black, White, Grey, Beige
30" **\$43.95**

#5 JACKET COIL 2-SLIDER

24" **\$50.45** Black, Lt. Grey, White
30" **\$55.25** Black, Lt. Grey, White
36" **\$58.75** Black, Lt. Grey, White

SLEEPING BAG ZIPPERS

#8 NYLON COIL 110" **\$13.60 each**
2 slider, Black only

BRASS JACKET • JEAN & PANTS ZIPPERS



530 567 576 578 156 546 839 560 580 519 849 527 501 571 564 573 569 570
 D. Green O.D. L. Grey M. Grey D. Grey L. Blue M. Blue Navy Black Red Orange Mauve White Natural Taupe Beige M. Brown Brown

JACKET ZIPPERS

- #5 **BRASS, YKK 1-SLIDER** *PER DOZEN*
 All above colors
 14" \$17.50 20" \$20.75 26" \$23.25
 16" \$18.50 22" \$21.75 30" \$25.25
 18" \$19.50 24" \$22.95 36" \$28.50
 48" \$42.50 Black Only \$3.98 each
- #5 **BLACK OXIDE, 1 SLIDERS, BLACK ONLY**
 30" \$31.95 36" \$34.50
- #5 **BRASS, YKK - 2 SLIDER, REVERSIBLE**
 Black, White, Navy, Beige, Brown, O.D., Red, Wine
 26" \$49.95 30" \$56.95 36" \$63.50
- #5 **BRASS YKK REVERSE SLIDER**
 30" \$5.49 each
- #10 **BRASS, YKK - Dk Brown, Black**
 24" \$6.25 30" \$6.65 36" \$7.25

JEAN ZIPPERS

- #5 **BRASS JEAN ZIPPERS - HEAVY DUTY** *PER DOZEN*
 9" \$10.25 11" \$11.95 All above colors
 5" \$8.60 7" \$9.95 Black & Navy
- #4.5 **BRASS PANTS AND JEAN ZIPPERS - REGULAR WEIGHT**
 9" \$6.25 } All above colors
 11" \$7.49 }
 3" \$4.99 Black Navy
 5" \$5.20 Black, Navy, Beige, White
 7" \$5.85 Black, Navy, White, Brown, Beige
 M. Grey, Dk. Grey, M. Blue, Olive
- #4.5 **ANTIQU BRASS JEAN ZIPPERS**
 11" \$11.45 Black, Navy, Dk. Brown, Beige, Lt. Grey

#5 ANTIQUE BRASS JACKET ZIPPERS 1-SLIDER

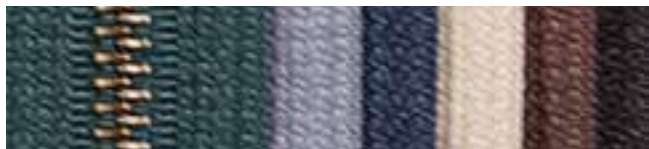

530 578 580 573 569 570

D. Green 830 M. Brown 569
 M. Grey 578 D. Brown 570
 Navy 560 Black 580
 Beige 573

- #5 24" \$24.75 } *PER DOZEN*
 #5 30" \$28.95 }
 #5 36" \$35.25 }
 #7 30" \$7.25 Black, Brown \$7.25 each
 #8 30" Import Black \$4.15 each
 #10 30" Black, Brown \$12.25 each
 #10 36" Black, Brown \$13.50 each

- #5 **ANTIQU BRASS, YKK 2-SLIDER**
 36" \$68.25 Black, Brown, D. Green \$5.99 each
 #10 36" \$14.99 each

COVERALL ZIPPERS *PER DOZEN*

- #5 **BRASS 2-SLIDER** 18" \$31.25 28" \$42.75
 Black Beige L. Blue 20" \$33.50 36" \$49.50
 White M. Brown M. Blue 22" \$35.75 42" \$51.75
 Navy Olive M. Grey 26" \$41.50

NICKEL PANTS ZIPPERS

- #3 **NICKEL PANTS ZIPPER** *PER DOZEN*
 11" \$13.75 Black, Charcoal, Navy Beige
- #4.5 **NICKEL PANTS ZIPPERS**
 578 580 571 570 501 573 572
 M. Grey Black Natural Brown White Beige L. Beige
 9" \$9.95 11" 11.45

ALUMINUM 1- and 2- SLIDERS

- #5 **ALUMINUM, 1-SLIDER** *PER DOZEN*
 Black, Brown, Navy, Grey, Beige
 24" \$15.75 26" \$18.15 30" \$19.95 36" \$25.30
- #5 **ALUMINUM, 2-SLIDER**
 30" \$44.75 Black 36" \$49.95 Black
- #10 **ALUMINUM, 1-SLIDER**
 Black, White, Navy, Beige, O.D., Grey, Red, Blue
 18" \$15.75 24" \$18.15 30" \$41.50 36" \$52.75
 48" \$65.75 54" \$69.95 60" \$8.25 ea. (Black only)
- #10 **ALUMINUM, 2-SLIDER**
 White, Navy, Beige, O.D., Grey, Red, L. Blue, Brown, Black
 30" \$59.95 36" \$66.00
 48" \$7.15 each 60" \$7.65 each (Black only)

ZIP-IN LINING ZIPPERS

- #4.5 **ALUMINUM**
 Black, White, Navy, Beige, Brown
 72" \$4.35 each 84" \$4.55 each

INVISIBLE ZIPPERS MAKE-A-ZIPPER ROLLS MAX



520	853	354	516	070	511	552	553	865	867	558	560	546	363
Wine	520			Rose	070			Purple	865			L. Blue	546
Fuchsia	853			Pink	511			Eggplant	867			*M. Blue	363
Mauve	354			Orchid	552			Royal	558				
D. Pink	516			Lavender	553			*Navy	560				



133	578	156	580	855	917	569	564	566	007	573	572
L. Grey	133			*Black	580		*M. Brown	569		Camel	007
*M. Grey	578			Rust	855		*Taupe	564		*Beige	573
*D. Grey	156			D. Brown	917		Olive	566		*L. Beige	572



533	548	877	830	536	532	501	571	055	089	506	522	820	519
Turq	533			Lime	536			Cream	055			Tomato	820
Aqua	548			Mint	532			Yellow	089			*Scarlet	519
Teal	877			White	501			Gold	506				
D. Green	830			*Natural	571			Peach	522				

INVISIBLE ZIPPERS PRICES PER DOZEN

#3	9"	\$6.35	} CHOOSE FROM COLORS ABOVE
#3	11"	\$7.50	
#3	22"	\$11.75	

#3	18"	\$9.60	Black, White, & Off White
#3	24"	\$12.95	Black, White, Natural & Navy
#3	30"	\$15.75	Black & White
#5	24"	\$5.15 each	Black & White & Off White

NEW MAKE-A-ZIPPER ROLLS



MAKE-A-ZIPPER

#2 INVISIBLE

4½ yd roll, 12 pulls

White, Black, Cream

each \$11.95



MAKE-A-ZIPPER

#5 HEAVY NYLON COIL

3 yd roll, 12 pulls

White, Black, Cream

each \$11.95



MAKE-A-ZIPPER

#3 NYLON COIL

5½ yd roll, 12 pulls

White, Black, Cream

each \$11.95

B&G imports "MAX" zippers. They are of high quality and exceptional value.

"MAX" JACKET ZIPPERS

- #5 **MOLDED** – Black, Navy
30" \$18.95 36" \$23.95
- #5 **BRASS** – Black, Navy
30" \$22.75 36" \$28.50
- #5 **ANTIQU BRASS** – Black, Brown
30" \$24.95

"MAX" BRASS JEANS ZIPPERS

Black, White, Navy, Beige

- #4.5 5" \$4.50 7" \$4.75 9" \$5.45 11" \$6.60
- #5 5" \$7.10 7" \$7.30 9" \$8.15 11" \$9.15

ZIPPER CHAIN by the YARD

Black & White

ORDER FULL ROLLS OF SPECIAL COLORS PRICES per 50 yards

- #4.5 ALUMINUM \$42.95 #5 MOLDED PLASTIC \$71.95
- #5 ALUMINUM \$48.50 #3 COIL \$38.50
- #4.5 BRASS \$57.95 #5 COIL \$52.50
- #5 BRASS \$66.00

See List

Since there are so many types of zippers available, we cannot list them all. If you have a special request, please ask, and we can probably fill your needs.

ZIPPER SLIDERS



MOLDED VISLON SLIDERS

#3 TOP Black White \$5.45	#5 HORSESHOE Black Navy Beige M. Grey \$9.65	#5 TOP (NEW) Black White Navy Beige Brown L. Grey M. Grey D. Grey Purple L. Blue Wine Red Yellow D. Green Follage Ant. Gold Ant. Silver \$5.45	#5 TOP (OLD) Black White Navy Beige M. Grey L. Grey Red Taupe D. Brown L. Grey Ant. Gold Ant. Silver \$5.45	#5 BOTTON (NEW) Black White Navy Beige Brown Red Foliage \$5.45	#8 TOP Black Brown Silver Ant. Gold \$7.25	#8 BOTTON Black Brown \$9.25	#10 TOP Black Brown Beige Olive \$7.45
--	---	--	--	---	---	---	---



JACKET SLIDERS METAL

#5 TOP NEW AUTOLOCK \$4.35	#5 HORSESHOE ANT. BRASS \$8.45	#5 LONG TAB \$5.45	#5 AUTOLOCK "OXIDE" \$5.45	#5 AUTOLOCK, TOP, ANT. BRASS \$5.45	#7 AUTOLOCK, TOP, ANT. BRASS \$11.95	#8 AUTOLOCK, TOP, ANT. BRASS \$13.49	#10 AUTOLOCK, TOP, ANT. BRASS \$14.49	#10 AUTOLOCK BRASS \$13.95 ALUM \$9.65
---	---	---	---	--	---	---	--	---



COIL SLIDERS

#3 Silver Navy Black White Brown \$3.15	#4.5 Black White Brown Grey Navy \$3.99	#5 Long Black White Navy \$4.55	#5 Horsehoe Black \$8.85	#5 Black White Navy Beige Silver \$4.55	#8 Black \$8.65
---	---	---	--	---	---

PANT #4.5 BRASS, NICKEL \$3.25	JEAN SLIDER #5 BRASS CAMLOCK \$4.25
---	--

TOP AND BOTTOM STOPS

Per 100
 #3 Top Gold or Silver **\$4.50**
 #3 Bottom Gold or Silver **\$4.50**
 #5 Top Gold, Silver, Black, Antique **\$4.50**
 #5 Bottom Gold, Silver, Black **\$4.50**
 #7 Top Gold, Silver, Black Antique **\$6.50**
 #10 Top Black, Antique **\$7.75**

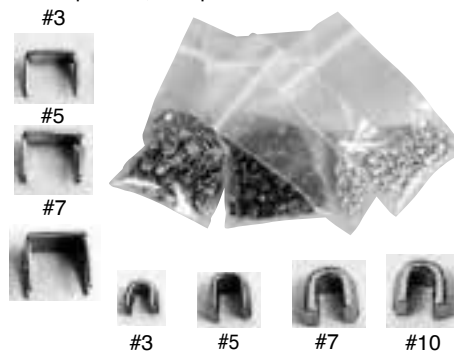

#3 #5 #7 #10

YKK SLIDER KIT



Contains good assortment of single and reversible sliders. Assorted colors and styles. Molded and coil #5 and #10
\$39.95

OLD STYLE #5 SLIDER TRAY



#5, Old Style, Single Tab, 8 colors. Molded, works on YKK and imports
\$38.50

ZIPPER PARTS KIT



Contains sliders for jackets, metal & plastic pants, skirts and dresses. Assorted top and bottom stops.
\$42.75

MACHINE THREADS

AMANN saba

#100 TUBES

1,000 meters

Long Staple Polyester Thread

Fine and strong, ideal for alterations of Men's and Women's garments, knits, wovens, silks, woolens and denims. **CHOOSE COLORS** from our **COLOR CHART** of 500 - Pages 35-38

1-9 \$2.59 ea 10+ \$2.49 ea

AMANN saba

#100 CONES

5,000 meters

Colors are marked with a circle **O** on our color chart, page 35-38. Order by the **O#** and the **COLUMN #**

\$12.49 ea 5+ \$11.49ea

AMANN saba #120 SUPERFINE

TUBES, 1000m, BL & WH
\$2.89 each

CONES, 5000M, BL & WH
\$13.45 each



#1000 tube
1000M

#100 cone
5000M

#30
300M

Buy your own real **THREAD CARD** for \$15.00

LIEBERSEW T40 Polywrapped Polycore

Strongest all-purpose, general duty thread. Fast colors

6,000 yd. CONES #50 / T40 \$9.79 each 3 plus \$9.25 each 10 plus \$8.45

1010	White	1183	Paprika Red	1414	Oriental Peacock	1640	Goebelin Blue	1663	Beaver	1709	Misson Brown
1800	Black	1184	Scarlet	1420	Churchill Green	1645	Lt. Navy	1672	Gypsum	1711	Mode Beige
1017	Antique Cream	1205	French Rasp.	1445	Spruce Green	1646	Dk. Blue Stone	1673	Reindeer	1750	Pearl
1018	Naturaline	1280	Toboggan	1462	Olive Drab	1647	Navy #3	1674	Taupe Beige	1759	Ascot Grey
1036	M. Yellow	1291	Amco Rust	1486	Dk. Aqua	1649	Midnight	1682	Toast	1765	Shadow
1037	Havana Brown	1305	Beaver	1502	Blue Baron	1652	Facile Beige	1684	Apple Sauce	1766	Leadville
1038	Lee Orange	1306	B-Taupe	1558	Hycinthia	1653	Dk. Linen	1687	Red Fawn	1776	Postman Blue
1042	Dk. Red Orange	1307	Manatee	1569	Purple	1655	Woodruff Tan	1691	Brown Chestnut	1781	Steel
1050	Leg Horn	1309	Beige Taupe	1591	Delta Blue	1659	Khaki	1694	Med. Brown	1795	Smoke
1054	Canary	1308	Oyster Shell	1592	Bali Blue	1659	Mauve Blush	1697	Chestnut	1797	Dakota Slate
1059	Solar Flare	1364	Green Shamrock	1611	Boston Blue	1660	Camel's Hair	1704	Dk. Covert	1798	Dk. Grey
1060	Gold	1385	Botanical	1613	Royal Blue	1661	Putty	1707	Colonial Brown	1799	Graphite
1124	Lt. Pink	1390	Dk. Green	1614	Glass Blue	1662	Camel	1708	Seal		



A&E DCore T40 Cotton Wrap Poly

100% Polyester sewing thread, vat dyed to insure colorfastness. Exceptionally strong for general sewing on men's and women's alterations. 6,000 yds. per cone.

each
\$16.45

4 or
more
\$15.50
each

PERMANENT STOCK COLORS

White	Bottle Green	43178	Foliage Green	504
Shickred	Midnight	32012	(12,000 yd)	
Scarlett	Navy#1	32737		
Khaki	Leadville	32086		
GOV00s-1	Coal Gray	32053		
OOT-1	Gun Metal	32033		
Camel Hair	32789			

Military, specified colors are in stock

COATS DUAL DUTY #70

CLOSE OUT

TUBES 2,000 yds
\$3.25 ea

C9710	Black	7930		
C1730	White	8228	Antique Cream	
1166	Leghorn	8526	Toast	
1414	Gold	8702	Rust	
2365	Lee Orange	9669	Leadville	
3873	Scarloet	9948	Charcoal	
3901	Wine	9967	Craven	
7553	Delta Blue	9979	Smoke	
7915	Navy #3			

NO BLACK

Bonded Nylon 33

4 OZ. CONES

\$9.95 each 6+ \$9.25 each



Black
Natural
Navy
Light Gray
Dark Gray
Camel
Rust
Orange

STRONGBOND NYLON 33

Black, White, 8oz. Cones

\$29.95 5+ \$26.95



SERGING AND BLINDSTITCHING EMBROIDERY THREAD

LIEBERSEW SERGING THREAD TEX-27

6,000 yd \$3.95 10+ \$3.75 ea.

Exceptional value for this excellent thread



Black
1183-117 Red
1205-123 Wine
1018-127 Off White
1120-151 Pink Hew
1173-164 Lt. Shock Pink
1218-166 Cerise
1568-198 Purple
1370-204 Lt. Chartreuse

1392-221 Pine
1430-227 Baby Mint
1431-236 Mint Aqua
1439-244 Turqu. Dk
1420-273 Dk Green
1502-279 Lt Blue
1613-293 Royal
1628-313 Cadet Blue
1644-319 Freed. Blue
1645-320 Navy
1649-323 Midnight
1592-329 Med. Blue
1761-334 Aluminum
1781-339 Med. Grey
1652-354 Lt Beige
1673-356 Cool Beige
1662-361 Lt. Latte

1309-364 Taupe
1759-368 Lt. Grey
1798-374 Dk. Grey
1799-375 Graphite
1052-380 Lt. Yellow
1456-391 Green Khaki
1663-400 Praline
1654-431 Sunny Beige
1655-429 Camel
1096-433 Sandalwood
1040-440 Lt. Copper
1028-457 Buff
1252-463 Pink Salmon
1691-491 Tobacco
1708-495 Dk. Brown
1709-499 Chocolate
1273-1402 Orange

ISACORD 40 EMBROIDERY THREAD - TEX 27 5,000 METERS \$9.35 PER CONE 5+ \$8.45



0017 White
1902 Dark Red
2715 Plum
3114 Purple
3333 Royal Blue
3355 Navy
3630 Light Blue
3641 Postman/ Med. Blue
5374 Dark Green
5005 Forest Green
5220 Light Green

0761 Deige
1375 Dark Brown
463 Olive
1115 Rust
0131 Light Grey
3265 Med. Grey
4174 Dark Grey
0020 Black

NEON AND OTHER COLORS ARE AVAILABLE

MINIMUM PURCHASE PER 6 OF COLORS NOT LISTED ABOVE.

MAXI LOCK T-27 3,000 yards

Maxi-Lock Serger Thread is made out of 100% spun polyester and is an all-purpose thread, most often used for sergers. The white color is a staple in any sewist's arsenal. It has 3,000 yards of thread.

\$2.79 each \$2.74 ea. for 6+ \$2.69 ea. for 10+

COLOR CHART LIST

270 Poppy Red
232 Eggshell
32365 Khaki
1228 Beige Taupe
13447 Red Currant

2235 Artillery
Boysenberry
8065 Steel
23629 Olive Drab
321 Bright Fushia
98 Purple
1036 Blue
23339 Navy
5005 Emerald
AE540 Sunlight
4455 Dark Pink

Maxilock Stretch T30

2,000 yards \$4.95 ea

Black
White
232 Eggshell
8065 Stell
2107 Med. Pink
2235 Artillery
23339 Navy
98 Purple



GLAZED COTTON 90/3 CABOT THREAD

For blindstitch and felling
12,000 yd. cones

White
Black
497
223
281
320
397
7256
1122
Navy
Chestnut Brown
Colonial Brown
Lt. Grey
Charcoal
Med. Grey
Beige
\$29.95 each



MONOFILAMENT BLINDSTITCH THREAD

Clear or Smoke

Size
#8 .004 1 lb. **\$27.95**
#13 .005 1 1/2 lb **\$37.95**
#18 .006 1 1/2 lb **\$37.95**



T-24 POLY CORE 6000yds Serging & General Sewing

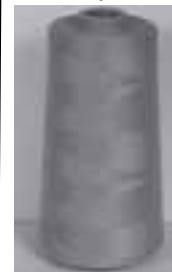

Black **\$5.75 each**
White **5+ \$5.19 each**
1183 Red
1682 Latte
1781 Med. Grey
1592 Lt. Blue
1614 Royal
1649 Navy
1759 Lt. Grey
10654 Yellow

SERAFIL

BLINDSTITCH & SERGING THREAD Size 200/2
Bonded of Polyester, finer than 120 poly or "0000" cotton thread.

20,000 METERS

1000 White
4000 Black
1222 Beige
1282 Graphite
2000 Bright White

\$25.95 each

5,000 METER

1000 White
4000 Black
504 Red
827 Navy
326 Lt Beige
1222 Beige
2000 Bright White

\$6.25 each

1382 Brown
413 Lt. Grey
415 Med. Grey
1360 Dk. Grey
329 Taupe
1043 Olive
1282 Graphite

3+ \$5.95 each



SOFT Z15

Nylon for hemming
4 oz. Cones **\$9.25**

S-1 Olive Drab
569 Dk. Grey-Brown
448 Reddish Brown (Bonded)
1357 Taupe
533 Camel
2966 Red
541 Tan
7861 Ivory (Bonded)
1563 Dk. Grey
White
Black

GUTERMANN SKALA HEMSHIRE

BLINDSTITCH THREAD



u151 10,000m FINE
000 Black
11 Lt. Navy
40 Grey
111 White
180 Med. Brown
195 Lt. Blue
232 Royal Blue
237 Med. Green
365 Red
368 Wine
464 Lt. Camel
467 Taupe
472 Dk. Green

540 Med. Brown
593 Postman Blue
633 Lt. Beige
676 Olive Drab
696 Chocolate Brown
702 Dk. Grey
810 Purple
824 Lt. Olive
854 Beige
924 Aqua

\$17.95 ea.

u151 20,000m
000 Black
111 White
702 Dk. Grey
854 Beige

\$32.95 ea.

u81 20,000m
000 Black
111 White
696 Dk. Brown
702 Dk. Grey
854 Beige

\$22.95 ea.

u81 5,000m SUPERFINE

000 Black
11 Lt. Navy
40 Grey
111 White
195 Lt. Blue
237 Med. Green
339 Dk. Navy
365 Red
467 Taupe
464 Lt. Camel
472 Dk. Green
696 Dk. Brown
702 Dk. Grey
854 Beige

\$8.15 ea.

GUTERMANN Serging Thread

M132/220, 5,000m
Black
White **\$14.50**
E382/80m 6,000m
Black **\$12.95**

HEAVY DUTY, TOPSTITCHING, LEATHER and UPHOLSTERY THREAD

T-105 6,000 yds Polycore CONE Heavy Duty

- Black
- White
- LEE Orange
- Red Fox - 531
- Med. Yellow
- Camel
- Gypsum
- Levi Gold
- Lt. Grey
- Midnight

\$32.50



T80 CONES 3,000 yds

- Black
- White
- Dk Brown - 499
- Havana Brown - 437
- Med. Yellow - 431
- Levi Gold - 481
- Lee Orange - 435
- (Camel) Toast - 479
- Pirate Gold - 427
- Gypsum - 354
- Midnight

\$8.95 ea.
3+ \$7.95 ea.

T80 SPOOLS 750 yds

- Black, White
- Royal Gold
- Havana Brown
- Med. Yellow
- Levie Gold
- Lee Orange
- (Camel) Toast
- Gypsum
- Pirate Gold
- Silver Grey
- Navy
- Brown
- Med. Blue
- Red Fox - 531

\$4.99 ea.
6+ 4.69 ea.



AMANN saba

Works great on BUTTONHOLE machines
GENERAL OR TOPSTITCHING THREAD
SABA 80/TEX40, 1000 METERS

4000 Black	1284 Dk. Blue/Grey
2000 White	1360 M. Green/Grey
660 DK. OD	1362 Dk. Green/Grey
822 Midnight	1363 Lt. Blue
821 Navy	
878 M. Blue/Grey	

\$2.25 each 5000M \$9.95

JEAN & TOPSTITCHING THREAD

Saba 30 / Tex 100, 300 meters **\$3.95**



Please choose colors from our COLOR CHART on pages 35-38.

#30 colors are marked with an X.

When ordering, please give us color X and the column # which go from 1-20

BUTTONHOLE MACHINE THREAD MARA 70 / TEX 40

M403 Guterman #70



\$3.29 each

Guterman	Guterman	Guterman	Guterman	Guterman	Guterman	Guterman	Guterman	Guterman
*000	106	*241	382	469	665	724	875	
*800	*111	*252	385	488	671	*727	883	
1	112	*258	*387	493	672	761	886	
5	118	*261	397	495	673	764	887	
6	124	263	399	*503	674	766	893	
11	141	288	401	528	*676	767	909	
13	158	299	402	531	678	769	919	
23	160	300	415	537	681	799	934	
*36	163	307	423	540	682	810	959	
38	174	310	429	542	689	815	998	
40	*175	322	432	585	694	816	999	
65	180	325	444	610	*696	*824	1254	
66	209	327	446	635	697	850	1655	
71	221	339	450	636	*701	851	4568	
93	222	365	464	639	702	854		
96	232	375	467	659	722	861		

STRONG BOND V40/69

Polyamide Very heavy duty thread
#90/92 also available
10oz.cone **\$29.95**
Black, Brown, Beige

BONDED NYLON 210

Very heavy duty thread
White, 1 cone **\$26.95**



CLOSEOUT "F" for TOPSTITCHING

navy, beige, grey,
brown.

\$2.00 each

BUTTON MACHINE, HANDSEWING, BASTING, DARNING & SPECIAL THREADS

BUTTON SEWING MACHINE THREADS

Glazed Cotton #70

BL, WH 12,000 yds
\$32.95



LIEBERSEW POLYESTER T27

for LIEBERSEW &
CHANDLER
BL, WH 6,000 yds \$3.75



FILLED BOBBINS



STYLE "L"

TEX 27
Black or White
1 Box of 144 \$36.95



Style "M" Filled Bobbins

white Tex27 poly thread
\$59.95 box of 1 gross

A&E Made in USA
Style L Bobbins \$44.95

STYLE " L V-15"

Poly, White
for EMBROIDERY
1 Box of 144 \$36.95



N.B.T. Hand Skeins

Waxed handsewing thread
Size A Silamide
675 yds. 1 oz. skeins

\$6.29 ea.

8 same color \$47.95

580 Black	566 Med. Grey
501 White	7278 Grey Green
7861 Off White	1563 Dk. Grey
70 Navy	577 Gunmetal
1910 Flesh	7256 Dove Grey
7259 Beige	814 Steel
541 Med. Tan	559 Nickel
1886 Putty	604 Lt. Nickel
483 Lt. Brown	620 Graphite
497 D. Khaki	569 Charcoal
533 Khaki	7280 Med. Blue
563 Dk. Beige	78 Royal Blue
944 Beige	44 Dk. Green
1357 Taupe	818 Light O.D.
568 Dk. Brown	S-1 O.D.
7273 Med. Brown	7290 Gold
419 Brown	2966 Red
451 Chocolate	7265 Dk. Red
1266 Dk. Brown	7267 Maroon
448 Dk.Dk. Brown	7287 Black Brown
7257 Silver Grey	



LIEBERMAN BUTTON THREAD #16

500 yds \$5.19



99 Natural	320 Lt. Grey	1122 Beige
497 Navy	318 Md. Grey	540 Olive
281 Brown	397 Dk. Grey	647 White
418 Med. Blue	475 Camel	647 Red
		Black

#24 800 yds, bl, wh, beige, beaver \$5.99

#16 4,800 yds, bl, wh, cone \$32.95

#24 6,000 yds, bl, wh, cone \$32.95

CROCHET BUSTLE THREAD

White, Black, ECRU
Braided Thread for
Bustling
Per spool \$3.49



BASTING THREAD



#70
Glazed Cotton
12,000 yds
\$32.95



#70
Glazed Cotton
1,000 yds spools
\$4.95

NOMEX FIRE RESISTANT THREAD #50

for uniforms, drapes, etc. 1/2 lb. cone \$69.95
Black, White, Navy, Beige

METALLIC THREAD

500 yds gold, silver \$5.25

DARNING THREAD #70 or #80

2,000 yds black, white \$4.95

GUTERMANN SILK BUTTONHOLE THREAD R753

800 Black	36 Dk. Grey
100 White	697 Dk. Brown
198 Beige	665 Navy
464 Tan	

ea. \$19.95
+5 ea. \$17.49



CLOSEOUT SILK MACHINE THREAD

Grey, Navy, Beige, Dk. Brown
Sizes OO, B, F 2/3oz. Spools \$5.00 each

PROFESSIONAL IRONS FOR EVERY PURPOSE B&G LIEBERMAN EXCLUSIVE IMPORTS

GRAVITY FEED IRONS

All gravity feed irons come with their own water tanks. In order to use tapwater you will add resin to demineralize it. The built-in filter prevents the resin from clogging the hose and iron. These irons are designed with a heat canopy to keep your hands comfortable.



**DL520
GOLD
EAGLE
IRON
\$109.00**

- U/L certified power cord
- U/L certified thermal cut-off fuse

Includes with shoe & resin



SILVERSTAR ES-300

GRAVITY FEED IRONS

Complete with Iron, Tank, Resin Filter, Teflon Shoe and Iron Rest. Power:120Volts (220v Available please inquire) Weight: 4.6 lbs. (2.1Kgs.) Base Size: 8 1/4" x 4 3/4" (209mm x 120mm).

Modern Body Design Convenient soft-touch button switch and rotary heat dial U/L approved thermostat. High Quality Steam Distribution Powerful steam generation Hard anodized aluminum sole plate. Comfortable urethane handle Heat Shield for added protection. Steam switch built into handle. Stainless steel & hard anodized aluminum base provides superior pressing surface durability.

\$129.00 *Includes shoe & resin*

**OPTIMA
ES-300**



\$109.00



- Professional strength self-contained vaccum
- Heated pressing surface
- Vaccum swing arm and heated sleeve buck
- Ships via UPS
- Economically priced
- Ideal for use with HI-STEAM mini boilers for a complete instant pressing department.
- Ideal for touch-ups for tailors, alteration rooms, drop-off stores, clothing stores, valet service, tuxedo and bridal shops.

**\$1,595.00
plus shipping**

**PND-2500A
Vaccum Board
(Full Line Available)**



Electricity	120V 5 AMPS 600 WATTS
Vaccum	42" X 15" X 9"
Machine Size	53" X 16.5"
Weight	Gross 83lbs Net 62lbs



**QUALITY IRONS
MADE IN ITALY**

ACA-1000 (3500) from Italy
Same iron CISEL sold before they closed. 3lbs. durable quality, 110V or 220V.
1 for \$159.00
2 for \$149.00 ea.



DRY IRON with Water Sprayer with smooth large base for shirt touch ups, 110v, from Italy. **\$204.00**



SVP-24 and MVP-35B mini boiler complete with professional iron. Ideal for tailors, alteration rooms, drop-off stores, valet service, tuxedo & bridal shops.

SVP-24 \$485.00

- Heats up in minutes
- Produces 40 PSI steam pressure.
- Uses ordinary tapwater.
- Patented copper chamber w/external heating element Eliminates major cause of burnout.
- Safety valve with interlock to prevent opening under pressure.
- Has steam pressure gauge.
- MVP-35B has gauge glass to check water, 6 hours of steam on one fill.
- SVP-24 lasts 4 hours on one fill.



**MV3-B
REPLACEMENT
IRON ONLY
\$149.00**



**MVP - 35B
\$559.00**

Mini boiler with professional iron

- Automatic pump water feed for pressing non-stop all day
- No plumbing connection required
- Uses ordinary tap water
- Little maintenance needed
- Patented copper pressure vessel with external heating element eliminates major cause of element burn-out
- Optional steam spotting gun

Perfect for busy pressing stations needing non-stop steam supply -- Busy dry cleaners, drop-off stores, tailors, alteration rooms, laundromats, sample rooms, bridal salons, tuxedo rentals, clothing stores, etc.

**MVP - 35 AUTO
Boiler With Pump
\$1,330.00**



MODEL	ELECTRICITY	STEAM PRESSURE	DIMENSIONS	NET WEIGHT
MVP-35B	120 V 15 AMPS	40 PSI	16"(D) X 10" (W) X 13" (H)	17 LBS
SVP-24	120 V 15 AMPS	40 PSI	15"(D) X 10" (W) X 11" (H)	15 LBS

Electricity	110 V 1 PH
Amps	15 AMPS
Cabinet Size	10.5" X 12.5" X 36"
New Weight	42 LBS

PROFESSIONAL STAINLESS STEEL STEAM BOILERS

4000IS \$699.00

120v or 220v
.66 U.S. Gallons - 2.5L
50 PSI - 3.44 bars
1-1000 watt
i30-800 watt
12 amps
Stainless Steel Tank

13"x11"x9"
cETLus approved
Made In Italy
Limited 1 Year Warranty
Lifetime Warranty on tank



5000IS (not shown) \$799.00

The i600 excels in producing quality, dry, pressurized steam. Pressurized steam is the fastest and most efficient way of ironing. It allows the fibers of the fabric to be softened quicker, with the weight and heat of the iron laying the fibers down flat. This creates the crisp and clean finish demanded by professionals.

6000IS \$1,199.00

120v
1.25 U.S. Gallons - 4.5L
65 PSI - 4.5 bars
1-1200 watt
i30-800 watt
12 amps, 20 amps plug required
Stainless Steel Tank
16.7 lbs - 7.5 kg (without iron)
13"x8.5"x11.75"
cETLus approved
Made in Italy
Limited 1 Year Lifetime Warranty
o tank



15-20 minutes heat up time
Rated for unlimited hours of use per day

Features:
i30 iron with 7" steam hose set
4 safety systems
Pressure Gauge
Silicone Iron Rest
Water level indicator window

7000IS \$1,699.00

120v
2.37 U.S. Gallons - 9L
Up to 70 PSI - 4.8 bars
2-1200 watt (1 spare)
i30-800 watt
12 amps
Stainless Steel Tank
31.5 lbs - 14.3 kg
12.95"x19"x20.5"
cETLus approved
Made In Italy
Limited 1 Year Warranty
3 Years on tank



30-40 minutes heat up time
Rated for unlimited hours of use per day

(Iron not included)

PROFESSIONAL VACUUM TABLES

6600VB \$3,499.00

.....110v
.....0.6hp
.....Standard
.....Vacuum only
.....52"x25"
.....#100628H, #100625H
.....221 lb - 116kg
.....62"x31"x70.75"
.....Italy
.....Limited 1 year



6200VB \$2,399.00 with sleeve arm

6000VB without sleeve arm \$1,999.00

.....110v
.....0.8hp
.....Standard
.....Vacuum only
.....43"x13.8"
.....2-pedal left or right
.....Integrated one piece
.....#100628H
.....175 lb - 79.3kg
.....62"x11"x71"
.....Italy
.....Limited 1 year



CRISP AND CLEAN FINISH

Pressing on a regular ironing board eventually leads to a damp ironing surface, making it impossible to get a clean, crisp finish for your garments.

FEATURES

- Fast start up motor to save time
- Exhaust chimney for air release
- Adjustable heating element
- Iron pad and cord support included

7600VB VACUUM & UP AIR PRESS \$7,799.00

110v
0.8 hp
Standard
Vacuum and up air
52" x 26"
Standard

Intergrated one-piece
#100628H, #100625H
292lb - 133kg
59" x 33" x 64"
Warranty 1 year
Italy



RELIABLE STEAM IRONS

2100IR 110v, 3.9lb \$199.00
2200IR 220v, 3.9lb \$199.00
2300IR 110V, 6lb \$239.00
2000IR without hose & plug \$159.00



Lightweight - 3.9lb
Right or left handed use
Stay cool cork handle
4-pin connector plug
Silicone iron reset
7' steam hose set

3900-IA HIGH PRESSURE STEAM BRUSH with ALUMINUM SOLE PLATE

120V \$299.00 220v \$299.00

Ergonomic handle
Plugs into "i" series boilers
High pressure steam
Bristles help remove wrinkles
Hook to hang brush
8.5" steam hose



IRONS & BRUSH CONNECT TO ALL BOILERS

AUTOMATIC STEAM IRON STATION 8000IS \$2,299.00

120V
Unlimited direct feed
1.25 US gallons - 4.5L
UP to 80 PSI - 5.5 bar
221° F - 105° C
1200W
17 amps
Stainless steel
Standard
Quick-release
26lb - 11.7 kg
12.25"x14.25"x20.5"
Italy
ETL Special
Inspection
Limited 1 yr.
Lifetime tank



The 9000IS provides continuous steam for an unlimited amount of time when it's hooked up to a direct water line or with the available 2 gallon water container. There's no more down time waiting for the boiler to re-pressurize. The 900 is the perfect choice for environments that require large volumes of uninterrupted steam.

9000IS

9500 BU
2 Valves
220V
(Iron not included)

The 900IS excels at producing quality, dry, pressurized steam. Pressurized steam is the fastest and most efficient way of ironing. It allows the fibers of the fabric to be softened quicker, with the weight and heat of the iron laying the fibers down flat. This creates the crisp and clean finish demanded by professionals.

120V
1.3 US gallons - 5 L - Unlimited
Up to 80 PSI - 5.5 bar
2 - 1200 watt each (1 spare)
i30/120V - 800 watt
17 amps, 20-amp plug required
Stainless steel
Standard
Quick-release
38 lb - 17.2 kg (w/out iron)
46 lb - 20.8 kg
11.5" x 11" x 39"
41.5" x 16" x 18"
Italy
ETL Special Inspection
Limited 1 year, Lifetime Tank



\$2,599.00

The Board 500VB

The 500VB with vacuum and up-air provides the user with the same tools that professionals count on.

HEATED PRESSING SURFACE

The secret to great finishing is to keep the ironing table dry by removing the steama from fabric. Use the vacuum for pressing a shirt or putting in a crease, while up-air (blowing) is great for delicates, removing the risk of leaving an impression or crush the nap.

** Optional sleeve arm and bottle holder.*

FEATURES:

- HEIghT ADJUSTABLE
30.5" - 38.5"
- PRESSING DIMENSIONS
16" W x 48.5" L
- 110V cETus



\$599.00

DL1900 A

HEATED VACUUM PRESSING TABLE with sleeve buck and bottle support pole

- Heating Watt 650w
- Vacuum 90w
- Volt 110v
- 53" x 16" x 35"
- Ironing Surface 43" x 15.5" x 9"
- Weight 75 LBS

\$995.00



IRON NOT INCLUDED

ALL IRONS NEED A STEAM SOURCE

DL85 STEAM ELECTRIC IRON



Traditional Cissel type design.
900 W Heating Element 110v or 220v
5 lb. 223mm X 119mm **\$84.00**

DL81 STEAM ELECTRIC IRON



900 W Heating Element 110v or 220v
4.4 lb. 179mm X 104mm **\$84.00**

DL-300H ALL STEAM IRON

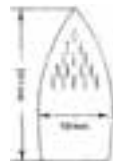

\$59.00

2 for \$105.00

- No electricity required.
- Operates on 80 PSI steam pressure.
- Requires steam and return lines with check valve and steam trap.

Unique internal design assures driest possible steam while maintaining a consistent sole plate temperature. Cool, comfortable handle. Thermo-Tech coating replaces heat shield which now protects operator's hand.

**ECO STEAM IRON
T-4 ALL STEAM
NOT PICTURED
\$69.00(No Hose)**

LAURASTAR Smart1

the active ironing board for a professional result



\$1,995.00

VACUUM SPOTTING BOARD Copy of Original Cissell

Built of cast iron the spotting board comes with a stainless steel working surface. Powerful vacuum on both the nose of the board and the swinging sleeve board.

Vacuum area is stainless steel with Teflon covering. The spotting gun allows use of steam, moisture and air for stain removal on any type of garment.

Three pedals control dry steam, wet steam and heated air.



\$3,500.00



IRONING EQUIPMENT



2010 Domostir 3000
 Economy Vacuum Board
 Surface
 Dimensions 45" x 15" x 9"
 120V 4.5 amps
 Ships via UPS
\$1,295.00
 With non-vacuum sleeve buck

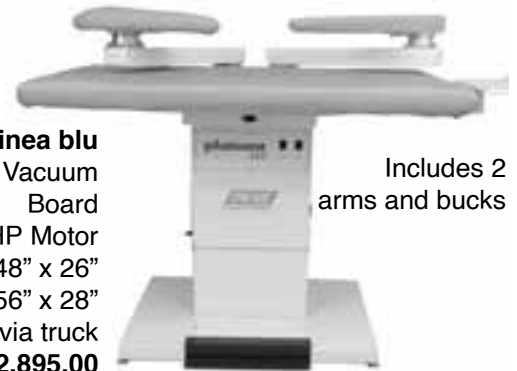

2161 Linea blu
 Rectangular Shape Vacuum
 Board
 0.75 HP Motor
 Surface Dimensions 48" x 26"
 Overall Size 56" x 28"
 Ships via truck
\$2,895.00

Includes 2
 arms and bucks

(Full Line of Machines Available) *SPECIAL ORDER ONLY*

OTHER MODELS FROM OUR MANUFACTURERS ARE AVAILABLE, PLEASE CALL!



FB-2000

Affordable blowing and
 vacuuming come together

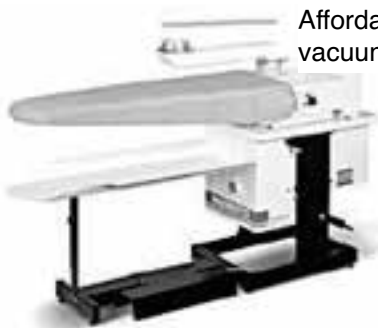

Utility Shaped Table
 Type 110v or 220v
 with swing sleeve arm
 47"x14"x81/2"
 Height adjustable
 850mm to 950mm
\$3,200.00



**NAOMOTO
 GRAVITY FEED
 IRON HYS58**
 110V /220V
 800W, 5LBS.

\$645.00

Micro
 Switch
 Steam
 Control

FBS-Y-6512



Rectangular Vacuum
 Table with utility buck,
 swing arm and optional
 sleeve buck to change
 out.
\$3,195.00

CREASET®

Permanent Crease Workstation for Pants.

Work Station Complete with compressor **\$995.00**

This permanent Creasing System.

Adds a profit center to your business while also helping eliminate
 double creasing in your pressing department.



Easily add \$5.00 profit for
 each pant treated

4 Cartridges, clear or black **\$54.98**
 10 Nozzles **\$29.98**
 10 Plugs **\$11.95**

INSPIRE 36®

**Table Top Mini
 STEAM PRESS**

MODEL:INSPIRE 36

The INSPIRE 36 steam press is one of the most electronically advanced units in its class. Professionally built, it has a computer controlled system providing the most accurate settings and safety features. The outstanding design allows the unit to be operated with one hand and dramatically reduces the ironing time by up to 50%. It leaves your fabric looking like it has just arrived from your local dry cleaner.

Ergonomic handle for easy operation

34" x 11" pressure surface

10 times larger pressing surface than regular iron

Maximum temperature 330°F

Safety alarm and auto shut-off

Powerful bursts of steam

Water tank 450 ml

Childproof safety lock

Woven press cover with pad

Accessory kit - pressing cushion, spray and water bottle



Optional ST-02 Stand
 (Sold Separately)
 Height 75CM or 30"

\$465.00

Model No	Watts	Water Tank	Weight	Packing
INSPIRE 36	1350	300 ml	9kgs 19.9Lb	1pc/ctn

STEAM EQUIPMENT, IRON

THREE AND FOUR-IRON BOILER

Requires water connection. Various heating element installation capability.

Supplied with three or four steam electric irons.

208V3ph or 220V1ph

Also available for all steam irons with return systems.

- Completely self-contained
- Dry Cleaners and tailors shops
- Automatic Water Feed
- Designing Rooms
- 80 psig Working pressure

STEAM ELECTRIC IRONS

- Open front design
- Steam shield
- Aluminum Sole Plate
- Weight 3½ lbs

\$179.00

PS201 (120v)

PS202 (220v)

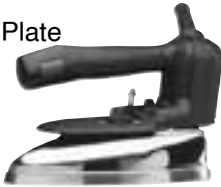

Complete Pacific product line available.



3 Iron Boiler
\$4,426.00

With Irons
\$4,741.00

4 Iron Boiler
\$4,500.00

With Irons
\$4,895.00

IRON STANDS



- Heavy Duty, all metal construction
- Height adjustment
- Floor Fastened, tripod leg design is perfect for locations with limited space.
- Connection plate for Lowboy or All-Steam Iron on PSI-142 and PSI-144

MODEL: PSI-143

MODEL	DESCRIPTION	
PSI-141	Iron Stand	\$248.00
PSI-142	Iron Stand with Lowboy/Steam Connection plate	\$290.00
PSI-143	Iron Stand with sleeve board	\$348.00
PSI-144	Iron Stand with Lowboy/Steam Connection plate and sleeve board	\$390.00

***** GENERAL BOILER PRODUCTS FULL LINE AVAILABLE

All sizes of Electric and Gas Boilers made to order.
See Minipac - page 49

LOW BOY SOLENOID ASSEMBLY

Features:

- Dry steam chamber.
- interchangeable with other brands.
- Easy to install and service.
- Choice of iron cable internal connections or quick connect iron plug with 4 wire cord.
- Lighted rocker switch.

All parts easy to replace if necessary.



\$675.00

HOFFMAN/NEW YORKER, INC.

HOFFMAN ELG-4 BOILER

US made, hand fillable.
Can be purchased with solenoid steam controller and iron or boiler only.

Full line available.

1.5 ELG4, Phase 1
volts 120, amps 13

Low water cutoff option

Water capacity 2 gal.

17 x 15½ x 25½

BOILER **\$2,295.00**

SOLENOID **\$109.00**



ONE IRON GENERAL BOILER WITH PUMP

ONE IRON BOILER with PUMP

80 lbs. operating pressure supplied with water jug and blow down jug, standard sight glass. Steam in 5 minutes. Requires 20AMP, 120V outlet. Pump allows you to refill jug while operating, No down time. 2 iron unit available in 220V/1ph

with 1 iron
\$2,195.00
with 2 irons
\$2,600.00



SHELDON BOILER AND ELECTRIC STEAM IRON

The Sheldon 2 gallon boiler with 5½ pound steam iron has been the standard in the industry for over 30 years. Quality made right here in Canada, the Sheldon boiler and iron provides continuous dry steam. Most trouble free boiler we found. No solenoid needed. Iron can be used with direct steam. Uses 2100 watts & 120v for complete unit.

SHELDON BOILER **\$1,649.00**

IRON 5 1/2 lb **\$395.00**

IRON 9lb **\$595.00**



STEAM EQUIPMENT

B & G LIEBERMAN EXCLUSIVE MINIPAC

This self-contained no vent, pre-piped system includes: Press (new or rebuilt) Vacuum (we recommend a minimum RP-2 placed right behind press for best suction), a hand iron and an electric 18 KW boiler which fits under the press table. Also includes pre-piped blowdown and baffle tank for proper and safe boiler blowdown with no vent to atmosphere. Installer only needs to pipe from blowdown and vacuum to floor drain and bring water and power to boiler.



HOFFMAN
NEW YORKER

PRESSING SYSTEMS

For truly professional pressing the good old "HOFFMAN" is still the king.

We stock

"NEW YORKER" & HOFFMAN
pressing machine parts.

GENERAL BOILER

SIDE VIEW OF MINIPAC

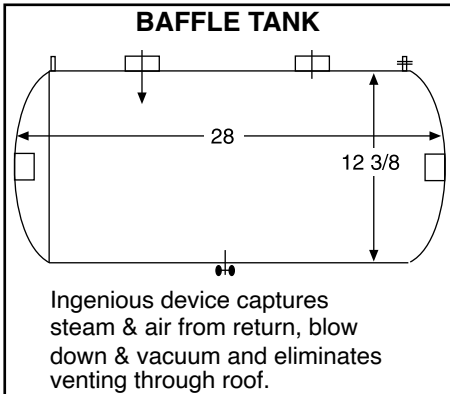
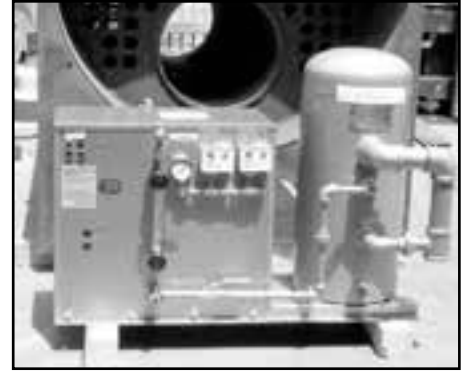

REMA

**VACUUM & CONDENSATE
RETURN SYSTEM**



Call us for specific styles to fit your need.



BLOW DOWN SEPARATOR

Steam boiler blow down separators safely reduce steam pressure for external venting. Water is drained through the bottom threaded coupling. Steam is safely vented out the top to the atmosphere.



IRON REST STAND

Portable, height adjustable iron stand. Angled for ergonomics. Does not require bolting.

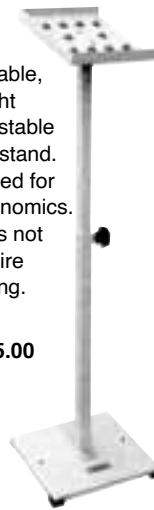

\$125.00

Reimers
ELECTRA STEAM, INC.

JUNIOR/ATLAS STEAM GENERATORS

Reimers Jr. Boiler, 120v

Hand filled unit can be purchased with Solenoid Steam Controller and iron or Boiler only. Quality, USA-made. JR-CUSTOM, KW 1.5 BHP .15 per hr 5 volts 120, wt 77 lbs.
Boiler **\$2,750.00**
Solenoid **\$109.00**



Iron not included. Full line & Auto fill units also available.

ELECTRIC BOILERS GENERAL'S REIMER'S LATTNER

Full range of electric as well as gas fired boilers to meet your specific needs. Please furnish us your requirements for the right Steam Generator for your application. Typical alteration department with one press calls for 1.8 HP boiler.

RH20 NEW Compact design fits under pressing machine table.



IRON REPAIR, HOSES, IRON SHOES, RESIN, IRON RESTS



7 FOOT TEFLON HOSE with stainless steel braid and outer covering with 1/4" fittings. Fits most "All Steam" and many steam electric irons. Most durable hose. 8 & 10 foot length also available.
 each \$17.95
 4+ each \$16.95



BLACK SILICONE HOSE with braid covering for steam electric irons and spotting guns.
\$3.95 per foot



HOSE CLAMPS for irons and spottin guns
\$0.95



SILICONE HOSE for gravity feed irons. This hose won't melt when irons touch it.
\$2.95 per foot



GRAVITY FEED IRON HOSE Clear plastic with silicone heat resistant end with spring.
\$11.95



HI-STEAM BOILER REPLACEMENT SAFETY FILL CAP
\$32.95
 Fits SVP.24 & MVP. 35B
2 GASKETS \$9.95



REPLACEMENT SAFETY FILL BOILER CAP
 Fits Reliable Boiler. **\$32.95**



WHITE TEFLON GASKET
\$12.95 FOR 2

ALL STEAM IRON HOSE COVERS

This hose cover will not slide up the hose because of the eyelet that fits over the exhaust knob on your All Steam Iron.

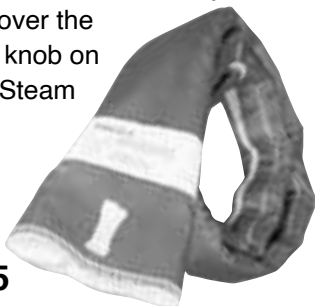

48" long
\$29.95

IRON SHOE WITH NEW DOUBLE LAYER METAL DIFFUSER

will not damage fine fabrics through excessive stem like regular iron shoe. **\$19.95**

IRON RESTS

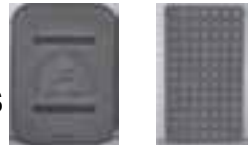

with metal liner Durable \$15.95
 Flexible pad \$8.95



IRON SHOES

prevent scorch and shine.
\$12.95
 Please specify model of iron and please keep a spare for emergencies.

FILTER RESIN



keeps your iron from clogging with minerals. Much cheaper than buying distilled water.
\$16.49

Gravity Feed Iron Water Filter Cartridge

Attaches below the jug, easy to change, no mess or leaking into hose. **\$10.95**



MOST COMMON GRAVITY FEED IRON PARTS



Rear switch cover set 1 **\$29.15**
 Switch cover only 2 **\$10.45**
 Thermostat w/fuse 3 **\$21.95**
 Solenoid Valve complete 4 **\$37.40**
 Plunger & Spring 5 **\$15.35**
 Microswitch 6 **\$19.75**

Many parts interchange with other brands

ACA-1000 IRON PARTS



MICROSWITCH fits most steam electric irons. Please provide make & model if yours looks different. **\$15.95**
THERMAL FUSE ACA-1000 IRON \$9.95
THERMOSTAT CISSEL ACA-1000 IRONS
 Other makes available **\$16.95**

STEAM REGULATOR

110v compact and easy installation. **\$109.00**
 The regulator controls the steam from the supply line. The microswitch on the iron handle opens the solenoid valve inside the regulator. Attached the steam regulator to the steam supply line and plug iron into Harting plug receptacle. The controller has an on/off switch and volume regulator knob.



CISSEL LOW BOY PARTS



PLUNGER CASINO SV-22 **\$29.95**
PLUNGER NEEDLE SV-50 **\$21.95**
SEAT for Low Boy SV-51 **\$9.95**
COIL for CISSEL Low Boy 110V, LB-231 **\$89.95**

4 POLE MALE HARTING PLUG



PLUG to attach to steam source.
\$26.95

REPLACEMENT SOLENOID VALVE

110v or 220v solenoids. Complete with needle valve and 1/4" thread to replace original equipment on General Pacific, Reimers, Hoffman or Veit boilers.
\$79.00



STEAMLINE CONTROL and PARTS

UNITED BRASS • COMPLETE PRODUCT LINE AVAILABLE



- | | |
|---------------------------|----------------|
| 1-Steamtrap 1/2" | \$79.50 |
| 2-Ball Valve 1/2" | \$28.75 |
| 3-Spring Check Valve 3/4" | \$77.80 |
| 4-Gate Valve #15 1/2" | \$33.90 |
| 3/4" | \$42.10 |
| 5-Swing Check Valve 1/2" | \$56.35 |
| 6-Strainer #200 1/2" | \$30.45 |
| with Steel Plug #200 3/4" | \$46.50 |

Specify Pipe Size to order correctly.



THERMOSTATIC BELLOWS TRAP TT 125, excellent for irons, economically priced, easy to repair. 1/2", 3/4" and 1".

\$70.00 1/2"

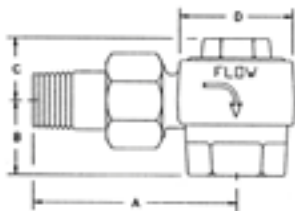

\$211.60 1/2"

THERMODYNAMIC TRAPS WD-600, works in any position. Snap opening provides purging action. Compact and easy to install. 3/8", 1/2", 3/4", and 1".

INVERTED BUCKET STEAM TRAPS

DAVID IMPORT

Provide efficient, economical condensate drainage for all types of equipment. Side inlet and side outlet. Can be supplied with integral strainer. pressures from 15 to 250 P.S.I. Sizes 1/2" thru 2".



1/2" **\$79.00**

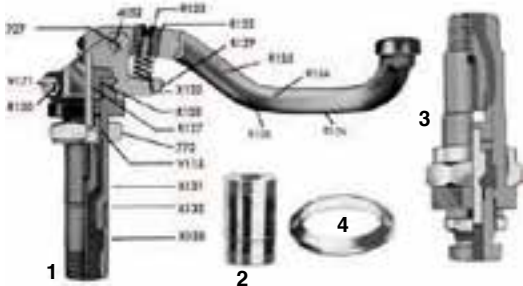

BOILER AND PRESSING MACHINE PARTS

1. Head Valves for HOFFMAN X, (R121A)
2. Diskholder V115 for Buck Valves.
3. Buck Valve X180 short, X185 long.
4. Head Valve Gasket V129T, Buck Valve Gasket V128T.

PRESSING MACHINE PARTS, HOSES AND SPRINGS

1. Teflon Hose TMF, 3/8" x 21"
Teflon hose TMM
2. Coversprings assorted length
3. Head Valve Spring X123 for R121A
4. Vacuum Pedal Spring V32 for HOFFMAN X
5. Head Valve Spring 777 for 140A & 141A
6. Teflon Thread Sealing Tape
7. Teflon Gasket 2999T for Teflon Hose TMF

Copper Screening by the yard or to fit your press, to be placed under padding. Order by Model Number.

PLEASE CALL FOR PRICES

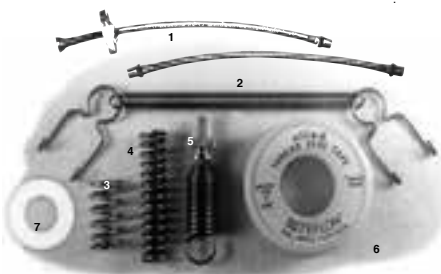

The steam drying device for the professional steam ironers. Eliminates water spotting.



Shown with CISEL iron. **\$69.95**



TEFLON BUTLER BEVEL SEALS FOR BOILER SIGHT GLASSES. STOPS LEAKS PERMANENTLY!

- Sight glasses cannot blow out.
- Visibility is always perfect.
- Fewer sight glasses needed.
- Maintenance labor cut to a minimum.
- Simple installation with instructions provided.

- 1- The Butler Seals are a patented, revolutionary device, precision manufactured to prevent leakage and cloudiness in boiler sight glasses. **Set \$33.95**
- 2- Best Quality Heavy Wall Red Line Glass 5/8" diameter, specify length for pricing. **\$33.00**
- 3- Gauge Glass Fixture with ballcheck 1/2" **\$109.00**

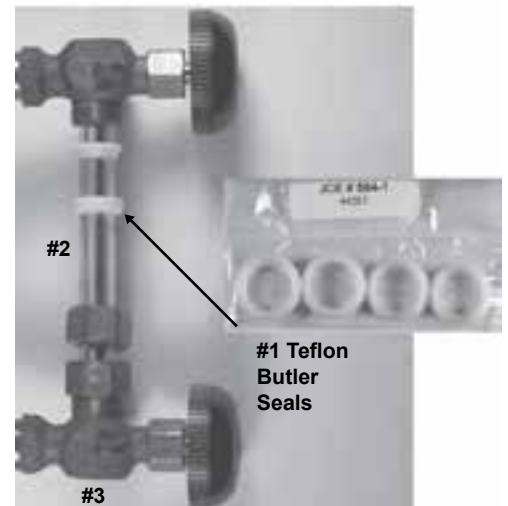

STEAMERS, SLEEVE BOARDS, TAILOR'S BUCK

SLEEVE BOARDS Padded & covered wood



24"
reversible
\$79.00

Replacement covers & padding for board available.

TAILOR'S BUCK Padded and covered wood



36"
\$149.95

Replacement covers & padding for buck available.

LADIE'S AND MEN'S SLEEVE PRESSING KIT



25" long 7 1/2" to 5 1/2" wide 1
24 1/2" long x 6 3/4" to 5" wide 2
16 1/2" long x 5 1/2 to 4 1/2" wide 3
6 3/4" long x 4 1/2" wide 4 } **\$44.95**

DRESS MAKER HAM



\$10.95

SEAM ROLL



\$16.95

HAND PAD



\$11.95

MITTEN



\$6.95

Needle boards and needle cloths are available. Call for details.

TAILORS VACUUM PRESS BUCK



with built in VACUUM 26" x 9" x 5", 110V. This Press Buck removes steam & dries garments faster. It stays dry all day. Saves time on under pressing. Use on your pressing or marking table. Plugs into standard outlet. Just turn on switch. Use your favorite iron with this nifty. **"NEW" TAILORS BUCK**



LIEBERMAN EXCLUSIVE \$129.00

BO-1 Import 25" Sleeve Board \$29.95



SLEEVE BOARD USA MADE \$48.95

Metal frame runs length of boards for strength.

Made of heavy 2" plywood construction. Standard board one side. Narrow sleeve board other side. Top board is 24" long x 42" butt tapered to 3" nose. Bottom board is 24" long x 4.5" butt tapered to 4" nose. Replacement covers No. SBC



BOSOM BOARD \$52.95

Metal frame runs length of boards for strength.

Made of Aluminum frame. Solid wood & 30 oz. padded flannel. These boards are built to last. Replacement covers & pads available.



VIVIO 170 GC



PROFESSIONAL GARMENT STEAMER

The Vivio 150GC is a professional grade garment steamer that is suitable for commercial or home use. The steam works by softening the fibers, allowing the fabric to relax. Wrinkles quickly disappear, leaving a finished and attractive look to your clothes.

BUY IT ONCE, BUY THE BEST

There are a lot of choices in fabric steamers, but the Vivio's unique combination of quality components, construction quality and simplicity make it an obvious choice for both pros and homeowners.

FEATURES

- Bottle won't fall off
- 1300W brass element
- Heavy-duty brass fittings
- Automatic shut off
- Easy roll casters
- Thermal fuse

\$199.00



Metal steam head. Wooden handle, 12lb, 110V, 1 gallon, 3 year limited warranty.



JIFFY STEAMERS

THE JIFFY STEAMER MODEL J-4000

- Removes wrinkles from most fabrics
- Two steam heads are available: Standard plastic head (J-4000) Metal head and wooden handle (J-4000M)
- Sight gauge for quick view of water level
- Automatic shut-off
- Convenient PREHEAT setting
- Made in the USA
- Shipping Weight: 26 pounds.
- Carton size: 20" x 12" x 14"

STEAMER CLEANER



Removes internal hard water deposits. **\$6.95**



\$309.00

ST-05 HANDHELD STEAMER

GOLD EAGLE PORTABLE STEAMER

\$43.00



CUFF SHAPA



Shape pant cuffs while you press them. Lightweight tool expands to fit; eliminates wrinkles **\$42.95** each Large; For cuffs 17-23" Small: 13-19"

LAUNDRY & DRY CLEANING NETS, COUNTER BAGS, CARTS, GARMENT FINISHING

NYLON LAUNDRY NETS

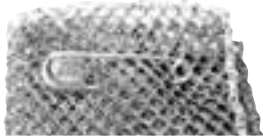

	1 - 3 Doz	4 + Doz
15" x 20"	\$42.25/doz	
18" x 30" white	\$60.40/doz	
24" x 36" white	\$60.40/doz	\$54.40/doz
24" x 36" colors	\$66.50/doz	\$60.40/doz
30" x 40" white	\$114.50/doz	

LAUNDRY NET PINS

Per doz	50	100
3-1/4": \$12.00	\$46.00	\$71.50
4-1/2": \$16.45	\$69.25	\$120.00
5" : \$18.95	\$76.95	\$137.00

Imprinted min. 50. \$35 charge

ZIPPER TOP NETS FOR DRY CLEANING

	Each	1 - 3 Doz	4 + Doz
small 18"x24"	\$6.50	\$62.50/doz	\$57.75/doz
medium 24"x36"	\$8.25	\$92.50/doz	\$84.50/doz
large 30"x40"		\$120.50/doz	\$108.00/doz
bridal 30"x60"	\$24.25		
bridal 36"x72"	\$26.95		
necktie	\$8.50		



NYLON COUNTER BAGS #0312

22" x 28" Royal, Green, Yellow, White, Red

1 dz	per color	\$34.00
50	per color	\$135.00
100	per color	\$259.00



POLY COTTON PICK UP BAGS 30" X 40"

Each	Per dz.	Per 100
\$3.75	\$42.95	\$305.00

NYLON PICK UP BAGS 30" X 40"

Red, Green, Blue

Per dz.	50	100
\$3.50 ea.	\$3.20 ea.	\$2.95 ea.

Imprinted per 100 \$324.50

Express Service Program

Custom Printed Counter Bags

Express Service is a system of counter laundry bags printed with your logo that carry tags coded to your customer's dry cleaning preference.



It's novel... it's a great "special service" to offer...and it's so convenient. 100% Nylon, 2 Grommets, Shoulder Strap or Hand Held Strap

Art charge included, with proof.

22 x 28 - 100 @ \$3.50	300 @ \$3.25	500 @ \$3.00
30 x 40 - 100 @ \$5.40	300 @ \$4.70	500 @ \$4.55

Customer ID Tags - 50 minimum.
This is an excellent service for your loyal customers.

OUR TIME SAVING PRODUCT, the ingenious "LIEBERLEGGER" CLOTH lets the presser press both pants legs at once. Simply place Lieberlegger between both legs. Saves half the pressing time. Does not diminish quality finish. Use the same amount of bottom and top steam as you normally would but give longer post vacuum for one or two seconds to ensure dry finish.



LIEBERLEGGER



42" Utility Legger \$69.55
Legger \$99.00

LIEBERFOAM

American made soft foam padding for Vacuum tables. We've supplied thousands of yds. of this to satisfied garments makers and cleaners. It's economy priced. Instant steam and vacuum. **LIEBERFOAM** replaces nylon flannel or felt.

It lasts for months.
18" wide, per yard \$39.95
Utility \$39.95 Rect. \$49.95
Sleeve \$19.95 Chest \$24.95



We need accurate measurements and correct Model Name and Number of your equipment

SILICONE PADDING FOR LAUNDRY PRESSES

Proven for decades as the ideal padding for Collar and Cuff presses. They give you perfect quality, better production, eliminate button breakage.
Standard Collar & Cuff Set \$89.95



6mm thick per m \$79.00

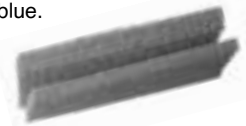

We need accurate measurements and correct Model Name and Number of your equipment

CANVAS BASKETS & TRUCKS

Steele

&



PRESS FABRIC & PADDING YARD GOODS

Spun Nylon Cover Cloth, 60"	\$16.50 per yard
Spun Nylon Cover Cloth, 7"	\$30.65 10 yard roll
Blue Cloth for Vacuum Tables, 54'	\$11.95 per yard
White Nomex heavy duty, 54"	\$58.00 per yard
Nylon Padding, 30oz., 61"	\$26.95 per yard
Nylon Padding, 20oz., 57"	\$15.50 per yard
Green Stretch Cloth	\$11.95 per yard
Nylon Padding, 50oz., 7"	\$34.50 10 yard roll
NOMEX 7" Covercloth	\$70.20 10 yard roll

Also replacement liners.
Swivel or rigid wheels or casters.
Up to 20 Bushel capacity.
Replacement casters available. Call for prices.



B U C K - E Y E
FH BONN
COVERS & PADS

Bonn's press pads and covers are recognized for their perfect fit. Each is tailor made to the exact specifications of the press. The better the fit, the better the finish, the longer the life. Bonn covers for shirt laundry bucks provide the best porosity to insure the best looking press finish.

PRO-FINISH DRY CLEANING PADS

- Excellent steam and vacuum flow
- Eliminates moiré patterns and seam impressions, they are oversized to better fit your press.

LAUNDRY COVERS AND FLANNELS

- Aramid fabric gives highest quality finish.
- "Quick Connect" hook and loop fastener provides easy installation and an airtight seal.

TEXSTEEL BASE PADS

Stainless steel woven mesh provides:

- High heat retention, quality finish.
- Superb resistency, long life.

FHBONN IRON RESTS - Total Security!

Protect your irons and shoes from damage.
Much better fit for UNIPRESS (Red),
FORENTA, CISSEL, AJAX (White) ea. **\$44.95**



NEWHOUSE

*Steam
Trap
Shields*

\$19.50



Uncovered Steam Trap



Covered Steam Trap



"ORIGINAL"
**Sankosha Covers and Pads
for Sankosha Equipment**

Call us for prices on your press models

E-Z OFF

For cleaning press
heads and irons.

Use while hot.

\$5.95



***From Air
World!***

Air World Grid Plates Features:

- **Double Layer Diffuser Design** (straight hole layer & diffuser layer)
- **Form Molded for a Perfect Fit Every Time**
- **Hi-Temp Cover with Moisture Repellent Treatment**

PLATE	LIST PRICE /PER
Utilities	\$111.80
Leggers	\$142.45

Available in All Sizes



DRY CLEANING PRESS PADS

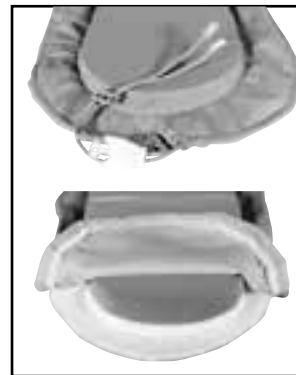

- Heavyweight wear resistant outer cover material.
- High Grade Latex Foam Rubber More than 3/4" thick.
- Best pressing quality and longest lift.
- Available in Slick Blue Poly and Nomex.
- All sizes available

Offers excellent & quick steam & vacuum. Very long life for an economical price.

\$94.00 Legger	\$70.55 Utility	\$49.60 Topper
--------------------------	---------------------------	--------------------------

Silicone Air World "Dream Pad"

Made from a high quality OPEN CELL SILICONE padding, this is a REVOLUTIONARY way to manufacture a press pad, making it much better than standard foam pads.

WHY USE SILICONE INSTEAD OF LATEX?

Silicone Foam LASTS 50% LONGER and BREATHES BETTER

Much More HEAT-RESISTANT than Latex Foam
Better Steam and Vacuum INCREASES

Productivity & Pressing QUALITY
DURBLE Under High Volume Conditions
Outer Cover Hi-Temp Fabric w/Water-Repellent Treatment

Available in Slick Gray Poly Fabric for

Pressers who Prefer Easy Sliding of Garments



OPEN CELL SILICONE PADDING
Best Steam and Best Vacuum



DRY CLEANING PRESS DREAM PADS

ITEM DESCRIPTION	PART #	Nomex Cover
38" Utility Press Pad	AWP.70-DP38N	\$99.35
42" Utility Pad	AWP.70-DP42N	\$106.50
Forenta 42YO, Cissel AU42	AWP.70-DP42SN	\$106.50
45" Utility Press Pad	AWP.70-DP45N	\$113.55
43" Utility Press Pad (AJAX 43C)	AWP.70-DP43N	\$106.50
47" Utility Press Pad	AWP.70-DP47N	\$113.55
45" Legger	AWP.70-DP45LN	\$146.95
Hoffman L8S Legger	AWP.70-DPL8SN	\$146.95
Forenta 47FGR Legger	AWP.70-DP47FGRN	\$146.95
FORENTA 48FGR Legger	AWP.70-DP48FGRN	\$146.95
AJAX 446 Legger with Cut-Out	AWP.70-DP446LN	\$146.95
446SE Legger with Straight-Back	AWP.70-DP446SEN	\$146.95
Cissell AOL45 Legger	AWP.70-DPAIK45N	\$146.95



Air World Inc.



**INTRODUCING THE NEW AIR WORLD PERFECT SHIRT SYSTEM
RED HI-TEMP COVER, WHITE MICROFIBER AIR BAGS
and PATENTED BLUE SILICONE FLANNEL PAD**

US Patent Number 8062742

If someone could help you reduce broken buttons and touch-ups you'd listen, right? Everyone is in search of the perfect shirt press right off the machine. And at Air World, we believe there's always room for improvement in your finished shirts. We call it the **RED, WHITE and BLUE...**



- AWU.04-O (UNIPRESS ABS SLEEVELESS AIR BAG (OVERSIZED))
- AWU.05-O (UNIPRESS ABS LEFT BAG COVER (OVERSIZE))
- AWU.06-O (UNIPRESS ABS RIGHT BAG COVER (OVERSIZE))
- AWU.10-S-8 (8 MM SILICONE PAD FOR UNIPRESS VASY/DAVY/CRD)
- AWU.10-CN (UNIPRESS OUTER COVER - VACUUM WITH DAVY, SAYV,
CRS, CRD ** BROWN NOMEX...
- AWU.09 (UNIPRESS DAVY/SAYV BODY AIR BAG)
- AWU.08-F (14x7 CUFF COVER 50 OZ. FLANNEL PAD)
- AWU.08 (UNIPRESS CCY CUFF COVER W/PAD (100% NOMEX))
- AWU.08-C (CUFF COVER (NOMEX) W/CORD)
- AWU.29-S (UNIPRESS VASY/CRS/CRD BODY COVER WITH SILICONE)
- AWU.11 (UNIPRESS CSF COLLAR W/PAD AIRBAGS)
- AWU.11-C (NOMEX COLLAR COVER UNIPRESS V3-P 20x10)
- AWU.12 (UNIPRESS CSF CUFF COVER W/PAD)
- AWU.01-O (UNIPRESS CSB/CDB BODY AIR BAG (OVERSIZE))

UNIPRESS ABS Sleeveless Air Bag Cover



Standard and Oversized

Stronger material for longer life

20oz. flannel pad sewn-in for wrinkle free pressing

Call for pricing

SILICONE COLLAR/CUFF PAD SET

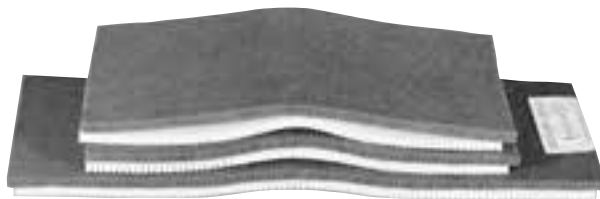

**10 mm Set - Retail Price \$105.00
(AW Code: AWC.24/25-10mm)**

- Used to replace Steel base pad.
- Remove old steel base pad and replace with 10mm silicone pad
- Install flat side up.

Saves buttons from breaking

Perforated holes allow excess moisture to escape and transfer heat for faster drying!

Blue Silicone Flannel Pad Price \$40.00 (AW Code: AWC.24/25-SF)

- Used to replace 50 oz. flannel.
- Install flat side up.

LAB TEST® + THERMAL DRY® + 490 PLUS®

**SAVE ENERGY & MONEY - KEEP PEOPLE COOL
ASK YOUR LIEBERMAN SALESMAN TO DEMONSTRATE**

INSULATING HEAD & BUCK COVERS

LONG LASTING MICROFIBER

- DURABLE CONSTRUCTION
- BURNOUT PROOF
- CLEANABLE
- REDUCES RADIATED HEAT FROM 300° TO 120°



INSULATING HEAD & BUCK COVERS are made for most DRY CLEANING and NOW also for "HOT HEAD" presses.

Important Note: Must provide make and model number of machine. Please indicate left or right press and indicate scissor, offset, or fast back.

Simple do it your self installation. Detailed installation instructions included in your shipment.

Collar/Cuff Insulator

Only from LABTEST® (PATENT NUMBER 5755049)



Insulating covers for all Laundry Presses. Reduce risk of burns to operators and maintenance workers. Create a more comfortable and productive working environment. Reduce radiant heatloss as much as 175 degrees.

490 PLUS® GRID PLATE

This cloth covered plate is used and recommended as original equipment by pressing machine manufacturers. The 490 PLUS® provides the highest quality finishing at competitive pricing. Longest lasting, best performing cloth plate available.

Proven Metal Diffuser



Reinforced Metal

LAB TEST® CLEAN PAD

The LAB TEST® Clean Pad has Teflon-Nomex surface that is excellent in preventing moire and texture marks on silks, rayons and other problem fabrics. The superior double layer construction provides excellent steam and vacuum passage. Excellent longevity.

Plastic Locks



SLICK PAD

A slick polyester surface for easy movement of garments. Double layer rubber and skirted construction provide better performance than competitive popular priced pads. Good steam & vacuum passage.

Plastic Locks



IRON PARKER

LAB TEST® IRON PARKER



PROTECTS YOUR IRON AS WELL AS YOUR TEFLON SHOE. RAISED EDGE PREVENTS IRON FROM BEING KNOCKED DOWN. TWO SIZES, SMALL FOR ALL CISELL STANDS AND LARGE FOR FORENTA.

PUFFER COVERS



PLEASE CALL FOR PRICES.

DRY-CLEANING, FINISHING BRUSHES & LINT REMOVERS

SPOTTING BRUSHES

21 **\$5.25** 
Black nylon.
Brush part: Small 1 1/16" x 1 3/8", Trim: 12"

129 **\$6.95** 
Extra heavy. White & black nylon.
Brush part: 2" x 3", Trim: 916"

B100HH **\$9.95** 
FINISHING & VELVET BRUSH
Horse hair.
Brush part: 8 1/2", Trim: 2 3/4"

B301 **\$6.95** 
SCRUBBING BRUSH
Palmetto. Trim: 1 1/8"

WHISK BROOM 11"
\$8.95 

960 **\$10.95** 
SUEDE BRUSH
Fine brass bristles.
Great for suede, rough outs and other nap raising uses.

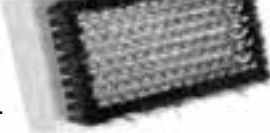
B105 **\$13.50** 
NAP BRUSH
Fine brass wire center with row of horse hair bristles on outside.
Kiln dried rock maple block.
Excellent for suede and other nap raising uses.

B308 **\$9.95** 
SMALL CARDER
small wire brush part: 3 5/8" x 1 1/4"

111 **\$18.95** 
FABRICOMB DEPELLER
Brass Teeth

111 **\$10.50** 
LINT CHASER
Wood and Brass

AIR WORLD JUMBO SHAVER
Electric, extra large Lint Chamber
\$36.95
Replacement Blade **\$3.95**



The GLEENER
is the most versatile FUZZ REMOVER to date. Three interchangeable blades will remove bulky, medium and fine pills. The velvet lint brush on the left will finish your revitalized garment.
Instructions included.
\$19.95
Replacement Blades **3 \$5.95**



Hipower PILL SHAVER



The end to Pill and Lint with this revolutionary technology that utilize vacuum suction. Will work with most commercial vacuums. It lifts pills and lint and shaves them off.
\$89.00
Vacuum not included.

Sweater & Fabric Comb
COLLINS
COLLINS
COLLINS



SWEATER COMB
Pill Remover
ea. **\$2.29**



PILL REMOVER
Black & White
per box **\$16.95**
Refills 3 ea. **\$15.50**



BONE SCRAPERS
ea. **\$4.45**



LINT MITTEN
Fabric nap picks up lint
\$7.95

CLEANING & SPOTTING EQUIPMENT & SUPPLIES

TEXTILE CLEANING GUN

with adjustable nozzle. Pressure can range from concentrated jet to a fine mist 110v/60

\$99.00



STEAM SPOTTING GUN

Hose optional

\$45.00



RAPID STEAM GUN

Adjustable Volume, Thumb Lever

\$99.00



LGW LITTLE GIANT WATER SPRAYER

Economical, great for Toppers, Suzies and shirt touch up and hand finishing, with or without hose.

Gun \$19.95 Hose 7' \$9.95



WATER SPRAY GUN, OVERHEAD

Use with Shirt unit, Offset Press, Puffers and Steam Air Finishers. With or without hose.

Gun \$44.00

Hose 7' \$18.00



CHROME NJECTOR PISTOL

Replacement pistol for cold spotting system. Repair kits available for some types.

\$139.00



LE-P A WATER MISTER
1/4" fitting. All metal design. Durable fine spray. **\$79.00**



2 BUTTON ELECTRIC SPOTTING GUN

for use on self contained spotting board with electric solenoid. **\$89.00**



COLD SPOTTING ADD-ON CONVERSION KIT

Use compressed air to prespot or post-spot any stain. The two containers are filled with a dry and a wet side chemical. The absence of steam prevents setting of stain and is easier for beginning spotters. Post-spot without leaving a ring. Fits most spotting boards.

\$645.00

COLD KIT installed on CISELL Spotting Board



VACUUM SPOTTING BOARD Copy of Original Cissell

- Built of long lasting cast iron spotting board comes with a stainless steel working surface.
- Heated compressed air guarantees quick drying.
- Powerful and concentrated vacuum on both the nose of the board and the swinging sleeve board allows the use of wet steam while keeping wetted areas from spreading and speedier drying times.
- The spotting gun allows use of steam, moisture and air for stain removal on any type of garment.
- Vacuum area is stainless steel with Teflon covering.
- Three pedals control dry steam, wet steam and heated air.
- The swinging sleeve board, for use on smaller areas, automatically applies concentrated vacuum when the sleeve board is moved into the operating position.



\$3,500.00

SPRAY TANK SYSTEM

Use for pre-spotting or to apply sizing or other products. Fill with chemical and air pressurize.

Complete Assembly

\$475.00



ELECTRIC DUSTER

- More economical than canned air.
- Environmentally safe.
- 500 Watt Dry Air Motor with 5 year warranty



\$94.95

REMOVE DUST

FROM YOUR SEWING MACHINE & ELECTRONICS

\$8.95



GARMENT HOLDERS

CHAIN TYPE

Chain type adjustable garment holder. Just press the lever to any height. Die cast zinc with aluminum tubing. Chrome beaded chain. Use at spotting boards, ironing boards and presses



\$5.95

REEL TYPE

The adjustable garment holder that really lends a hand at the press machine, silk finishing board, spotting board and repair department. Keep garments off the floor and wrinkle free. Spring loaded reel with strong monofilament cord. Just press the lever to adjust to any height desired.



\$24.95

CLEANING & SPOTTING EQUIPMENT & SUPPLIES



Leading in Cleaning since 1898

DRY CLEANER'S SPOTTERS KIT

\$109.95

Spotters have excellent small tips for applying 1 or 2 drops at a time. *Buy the kit and you get an extra SPOTLIFTER II*



ALBA RUST	NO1043	rust remover	\$23.95
ALBA INK	NO1044	ball point, oil, grease	\$25.95
ALBA PRO	NO1501	blood, milk, food stains	\$9.95
ALBA PSRII	NO1060	Powdered Dry Cleaning Spray	\$16.95
ALBA TAN	NO1505	coffee, tea, beer, fruit, berry, grass, softdrinks, juices	\$9.95
N.P.E. II	NO4416	No trichloroethylene oil, grease, dirt screen print	\$19.95

EVERBLUM® GOLD DRY SPOTTER

EVER BLUM® GOLD™

Cleaning Fluid is a unique, fast-drying, non-flammable cleaning fluid. It has a very low odor and is ideal for the cleaning of all textiles including apparel, bedding and furniture. It does not contain any chlorinated solvents.

This unique solvent is not considered a hazardous material for shipping.

- Apply by hand or in spotting gun.
- Removes grease oil & dirt.
- Leaves no residue stains
- Safe for use on all fabrics.

1 gallon \$84.95

16oz \$17.95



ALBATROSS EX3000 TEXTILE CLEANING GUN

High quality spot cleaning gun at a low price. It is perfect for T-shirt shops, embroiderers, retailers, tailors, drapery workrooms and other intermittent use applications.

- Adjustable Nozzle.
- Air Vented Housing to Keep Gun Cool.
- Powerful Pinpoint Steam.
- Brass Pump Cylinder.
- Adjustable Flow Rate.
- Large Capacity Canister.

\$209.00



SILICONE SPRAY

\$11.95



ANTISTAT STATIC ELIMINATOR

\$7.95

GUN REEL & IRON BALANCER



Reel suspends gun over the cleaning surface for safer handling and faster operation. Tough steel case and heavy duty balancing spring assures life-long and trouble free performance. Use with all Guns and irons.

\$49.95



CHEESE CLOTH
80yd box **\$99.00**

EVERBLUM APPLICATOR TOP

COSMETIC STAIN REMOVER
8 oz.

\$24.95

removes wax chalk residue



JANIES DRY STICK & CARPET CLEANER

\$5.95



LAUNDRY STICK

Stubborn Stain Remover
Handy, Push-Out Stick
Replaces Magic Wand
\$3.95



Alba Chem HLR

Finally a way to remove heat seal patches, emblems & bar code labels & glue from garments.

\$24.95



amodex

The amazing NON-TOXIC ink and grease remover that doesn't have any volatile solvent in it.

Removes all types of inks from delicate fabrics without damage. Use like a soap. Rinse out with water. Even removes waxy residue from tailor's chalk. Amodex has been removing ink stains since 1958.

4oz. bottle **\$10.95**



16 oz.

JINX INK®

INK STAIN AND SPOT REMOVER
REMOVES MOST ALL TYPES OF INK STAINS FROM CLOTHING, CARPETS AND UPHOLSTERY.

- ALSO REMOVES
- FINGERNAIL POLISH
 - PASTE SHOE POLISH
 - LACQUERS • GLUE
 - ADHESIVES • TONER

FOR WET/DRY SIDE
PAT.NO 4, 145,226
FOR ACETATE, RAYON, SILK
USE JINX INK - DF

\$15.95



INK & SPOT REMOVER

Each **\$2.25**
Dozen **\$23.95**

INK CLEANER
For Cotton, Wool & Synthetics
ea. **\$2.95**
dz. **\$26.95**



KEEP YOUR CUSTOMER HAPPY WITH "IMPRINTED" GIVEAWAYS YOUR CUSTOMER REMEMBERS YOU!

DO YOU REMEMBER THE "PANIC BUTTON"?

A beautiful pearl-looking shirt button on a stickpin with a jewelry catch in back.



We stock 18L and 14L
1 Gross (144) with
generic cards
1000 with
"imprinted" cards

Available with a stock print card or for the promotion minded Dry Cleaner we suggest cards with your special imprint.

Did you lose a button on your shirt?
No problem, stay calm...
Here is your FREE
PANIC BUTTON
to help you out and
as a service to you we will sew on a new button
the next time we launder your shirt.

Courtesy of

Your Name

PANIC BUTTONS 1gr.	\$ 62.20
PANIC BUTTONS 1000	\$435.00
with generic cards 1 gr.	\$ 71.95
with business cards	\$520.00



To affix the CollarSTYX™ to the underside of your collar:

Box of 250 sets **\$54.00**
Box of 500 sets **\$104.95**

- 1 - Peel the CollarSTYX™ from the release paper backing.
- 2 - Align printed arrow with the point of the collar lapel.
- 3 - Press together with thumb and forefinger.

COLLAR STAYS

2½" or 3¼"
400 Per box.
\$24.00



IMPRINTED MINI LINTROLLERS

144 **\$165.00**
288 **\$285.00**
print charge **\$120.00**



Custom Imprinted Collarstays

WITH YOUR LOGO



Box of 7200 collarstays
with your Logo or Name.

7200 2½" x ¾" **\$306.50**
7200 3¼" x ¾" **\$357.00**
Ink colors – Silver, Gold,
Gold, Black, Green,
Blue, Red

CREATE A PROFIT CENTER FOR YOUR BUSINESS AND SERVE YOUR CUSTOMERS AT THE SAME TIME

COLIBRI MOTH REPELLENT

LINT BUSTERS

with 12 handles **\$33.50**



CLOSET HANGERS

10 Cedar **\$29.95**
10 Lavender **\$29.95**

SACHETS

10 Cedar **\$23.95**
10 Lavender **\$23.95**



IMPORT LINT ROLLERS

Box of 1dz. **\$11.95**



12 INDUSTRIAL LINT BUSTERS

with metal handle **\$27.95**
without handle **\$25.95** handle **\$3.49**



FLASH TAPE

\$5.99 each



UNIQUE LINT BRUSH

Reverse nap to
clean brush

\$3.45 each

\$39.95
per dozen.



FABRIC DEPILLER

1 dozen **\$29.95**



GARMENT BAGGING MACHINES & RACKS

HAWO 630 K & 630 KP



Finally a garment cover made from natural compostable material, not petroleum based, causing no damage to the environment. The length of the film can be precisely tailored to the packaged garment. Hence packaging that is too short or too long is a thing of the past. Air can circulate easily within the packaging. **Call for roll sizes and prices.**

No heating time, ready for immediate use.

No additional cutting process necessary (integrated cutting wire seals and cuts at the same time).

Infinitely variable sealing time interval, acoustic sealing time indicator (can be switched off).

Especially suitable for polymeric materials as well as compostable and biodegradable materials such as ORGANIX.*



STARTING AT \$3,395.00

BAGGING JACK K 32

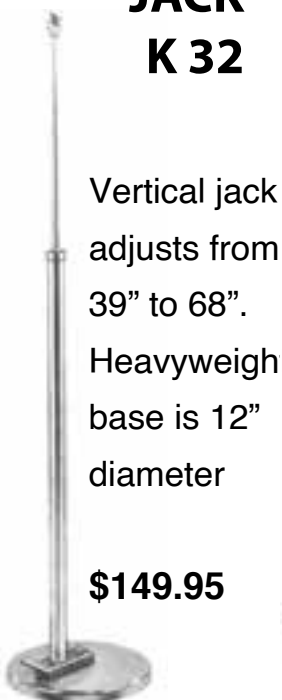

Vertical jack adjusts from 39" to 68". Heavyweigh base is 12" diameter

\$149.95

THREE ROLL GARMENT BAGGING RACK K30



\$149.95

ONE ROLL BAGGER K 31

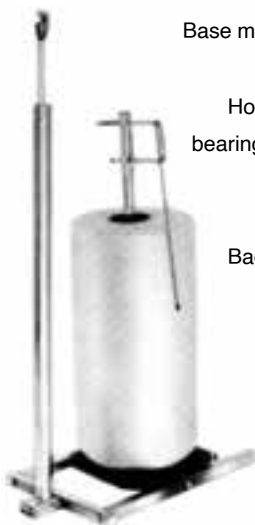

Base made of 1"square tubing.

Holds 1 roll of poly on ball bearing mounted platform for ease of turning.

Bagging jack adjusts from 39" to 68".

Floor space required 13" x 18"

\$89.95

MANUAL HEAT SEAL BAGGER

SNC-63WS

This bagger requires only 1 roll of non-perforated poly for perfect bagging instead of various lengths. Just pull down enough to cover garment and press buttons to heat and seal. This Bagger eliminates the bagging jack pole that so often breaks.

2000 garments per hour
2 year parts warranty
No air, only electricity 110v

Timer adjusts to most plastics. (PP, PE, etc.)

\$3,295.00



POLY ROLLS

Clear, Perforated
0006 Gauge, 1563ft
21" wide, 9" gusset



Continuous heat seal available

42"- 469 bags per roll
54"- 347 bags per roll
\$63.00 per roll

72"- 156 bags per roll
\$76.95 per roll

GARMENT RACKS

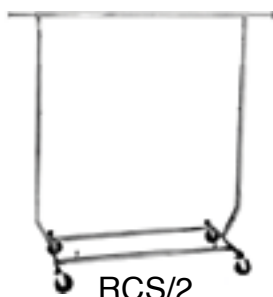

RCS/2

\$131.95

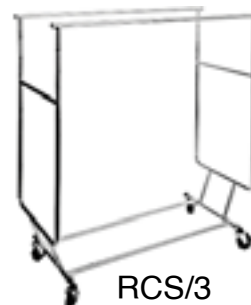

RCS/3

\$189.95

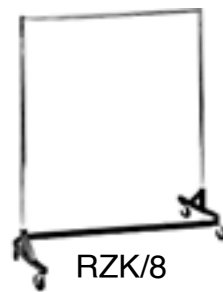

RZK/8

\$129.95

WORKBENCHES, PANTS HORSES, CHAIRS, MATS



ANTI FATIGUE FLOOR MATS

Try the Softest, most Durable, Orthopedic, FLOORMAT. Impervious to chemicals, acids and petroleum products. 3/4" thickness-see insert.

Grey or Black

For custom size please supply dimensions.

24" X 42" X 3/4" **\$78.00**

20" X 33" X 3/4" **\$61.00**

10% discount when you order two or more.

KNEE PADS

17 1/2" X 10"

1/2" thick

\$16.50 each

3/4" thick

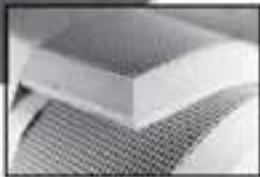

Make your own runner, mats by the foot

Standard Width	Price (each)	Lbs
22"	\$20.00 per ft.	1.20 per ft.
24"	\$25.00 per ft.	1.28 per ft.
36"	\$38.00 per ft.	2.00 per ft.
42"	\$40.00 per ft.	2.24 per ft.
44"	\$42.00 per ft.	2.44 per ft.
48"	\$50.00 per ft.	2.56 per ft.

* By the foot pricing available on mats over six feet in length. Factory bonding every six feet or when necessary*

WORKTABLE FOR MARKING AND PREPARING ALTERATIONS

TOPS
PLASTIC LAMINATE "B" OR SOLID MAPLE "C"

30 X 60 (MOST POPULAR)
30 X 72

TOPS
36 X 60
36 X 72 POPULAR

LEGS: ADJUSTABLE HEIGHT, HEAVY DUTY
13 GAUE STEEL
4 CROSS BRACES 30" OR 36"
3 STRINGERS

OPTIONS: BACK & END STOPS
LOWER SHELVES
RISERS
STEEL DRAWER



CHAIRS

LASTING...ENDURING

A true ergonomic industrial chair that comes standard with pneumatic height adjustmet. fully adjustable back, 360 degree swivel, and a five leg base, contoured seat for added comfort and fingertip levers for easy adjustments. Wide seat, black.

\$188.00

CALL FOR QUOTATIONS.
Other colors available.



TILT-BINS

The ideal way to keep buttons and little things. Each compartment tilts for easy access. Design your own system T-BIN show has two 9 bin units and four 6 bin units. Each compartment lifts out for refilling. Available with steel wall mounts rails for free standing base (shown).



Call for prices

9 bin row unit
\$29.00

6 bin row unit
\$34.00

5 bin row unit
\$54.00

Components sold separately
24" Rail for Wall Mount **\$32.95**

B.G. LIEBERMAN CATALOG INDEX 2022-2023

A	F	Marking pens	28	Sleeve heads	24
A&E DCore Thread	Facings, hem	Marking Aids, Pen	28	Sleever covers, forms (call)	59
Air World (full line available)	Fairgate rulers	Mats, Anti-Fatigue, Rotary, Cutter	16, 68	Snag repair tools	13
Albatross products	Filled Bobbins	Measuring Gauge	13	Snaps & Tools	27
Alteration instruction books	Fire Retardent Tape	Mending tape	30, 31	Snugtex	23
Alteration Tags, Supplies	Floor Mats	Merrow Machines	7	Solenoid Valve	57
Amann-Saba Thread	Fray Check	Mini Pac	56	Spark Organdy Tape	22
Anti-Fatigue Mats	Fusibles	Moffat Lamps	17	Spotting board	53
Anti-Static-Guard	Fuzz remover	Moth deterrent	66	Spotting chemicals	65
Apron Strings	G	Mundial scissors/shears	14	Spotting brushes	63
ASCOLITE button shank wrapper	Garment Bags, Rack, Covers	N		Spotting guns, system	64
ASCOLITE yarn	Garment Finishing Holders	Naomoto	54	Spray Tank System	64
AWL	General Boiler Equipment	Napbrush	60	Stain Pen	65
AZ Tracks, TUX	Gleener Fuzz Remover	Neck pads	22	Steamers	59
B	Glue Stick, Glues, Cement, Adhesive	Needles, hand sewing, machine	12, 13	Steam Finishing equipment	51-56
Babylock Knives	Gold Eagle Equipment	Needlenose Pliers	18	Steamline Control & parts	58
Bags, counter & pick-up, nylon, comforter, sweater, blanket, dress	Grid plates	Needle Plate	10	Steam Regulator	57
Baggers	Gripper snaps	Needle Threaders	13, 19	Steam Traps-Kaps covers	58, 61
Bagging Machines	Gromet Pliers Press-N-Snap	Nets, laundry, pins	60	Steam valves	58
Baskets, canvas, poly	Gun Reel/Iron Lifter	Newhouse products	call for info	Stitch Witchery Wonder Stitch	22
Beeswax	Gütermann Thread	New York presses	56	Strap Adjusters	26
Belting	H	Nippers	14, 15	Superpac	56
Bindings	Hangers	Nylon Padding	23, 60	Sweater Comb	63
Blade/Neck Pads	Head covers	O		Swimsuit Rings Hooks	26
Blanket bags	Heat Seal Machines, Tape	Olfa Cutters, Mats	16	T	
Blind Stitch Machines, Parts	Hem facing	Overall Buckles	36	Tach-It	28
Blowdown Tank	Hem markers	Overlock machines	7	Tags, invoices, tickets	
Bobbins, bobbin cases, holder	HI-STEAM Boilers	P		we special order	26
Boilers	HI-STEAM Vacuum Board	Pacific Steam Equipment	55	Take-Up Spring	10
Bonn, F.H. products, Buckeye (full line available)	Hoffman machines & presses, irons	Padding	23, 60	Tailor's Bucks, covers & pads	59
Bone Scrapers	Hold Tight Adhesive	Pads, shoulder, knee	24, 25	Tape measures	20
Boning	Hole punch, OSBORNE	Panic Button	66	Tapes, mending, iron-on, reflective	30, 31
Books	Hooks & eyes furrier, bridal	Pants topper covers & pads	61, 62	Teaching Manuals	26
Bowtie Hardware	Horse hair braid	Patch-it mending kit	30	Teflon seals	58
Braid	Hose, Teflon, covers	Pellon	22	Teflon hose & shoes	57
Bra Cups	I	Pens, Disappearing Ink	28	Thermal Dry Hot Pads, Heat Retentive	62
Breast cups	Industrial Bobbinwinder	"Pill" Remover	63, 66	Thimbles	13
Bridal Gown Covers, Bags	Ink pens, erasable, vanishing	Pincushions	19	Threads	47-50
Brushes, Nap, Finishing, Dry Cleaning	Insulating Covers	Pins, straight, safety, T-pins	13	Thread Color Chart	37-41
Buckles	Interfacing & interlining	Plastic packaging	29, 67	Thread bed, racks, stands	17
Button backers	Iron cleaner	Pocketing	23	Tilt Bins	68
Button Card	Iron shoes, rests, resin	Poly Bags-Roll Film, Heatseal	29, 67	Tools	19
Buttons	Iron Repair, parts, stand, hose	Poly Boning	22	Tools for the Trade	13
Button Sewer, Chandler, Juki, Liebersew 7, 8	Iron Stand Air World	Pressing Aids	59	Trevil Finishing Equipment	54
Button Covering Machine	Irons	Presser feet	10	Trouser marker	20
C	Iron-on tapes, patches	Pressing equipment-parts	51-58	Tweezers	13
Canned air (Blow Off)	Ironing Board covers, aids	Pressing Mitt, Pad	59	Twill Tape, Staytape Cuffbinding	22
Carder	J	Press-N-Snap	27	Twistems	28
Chairs	Jacket snaps	Press pads, plates, covers	61, 62	Twist-Ty Machine, refills	28
Chalk Powder, Pencils	Jean Buttons w/tack	Puffer Covers	62	U	
Chalk, Tailor's, Sharpener	Jean snaps	R		Unipac Baffle Tank	56
Checkvalves	Jiffy Steamers	Rack Dividers	29	US Stitchline	9
Cheesecloth	Jinx Ink	Racks Rolling	67	United Brass Parts	58
Chemicals	Juki Sewing Machines, Parts	Razor blades, X-Acto	16	V	
Clean pad (Lab Test)	K	Ready-wound bobbins	50	V-bolt	11
Clips, Hanger, Skirt, Thread	Knit cuffs & waistbands	Reimers boilers/irons	56	Vacuum tables, boards	51-54
Clover Tools	Knee, Lifter pads (rubber), pads	Reliable Equipment	52, 53	Velcro	18
Cold Spotting Conversion Kit	Knife sharpener	Rema equipment	56	Velvet Boards, Velvet Brush	CALL
Collar & Cuff Pad Sets	Knit Picker	Resale items	66	Vinyl zippered bags	29
Collar stays, Styx	L	Resin for irons	57	W	
Color Chart	Lab-Test products	Return Systems - Baffle Tanks	56	Waistbanding	23
Consew Sewing Machines	Labeling Machine, EZ Press cartridges	Rulers	20	Walkingfoot machines	5
Cord, Cotton	Lamp, flexible arm, bulbs, halogen	S		Water spray guns	64
Cosmetic remover	Laundry items	Saba Color Chart	37-41	Whisk broom	63
Cover cloth cotton, NOMEX	Lattner boilers (please inquire)	Saba Number chart	44	Wigan, cuff	22
Coverstitch Sewing Machines	Laundry baskets	Saba Thread	47, 49	Wonderstitch	22
Creaset	Laundry cover & pads	Scissors, Wiss, Fiskar, Mundial, Sharpeners, Gingher	14, 15	Work tables, hand finish bench	68
Cuff Shapa	Laundry net pins	Seam binding	22	X	
Cutters ROTARY, ELECTRIC SHEAR	Leather cement, tape	Seam rippers	16	X-Acto	16
D	LED Lights	Seam Roll	59	Y	
Dennison Fasteners, guns, needles	Lieber Legger Cloth	Sergers		Yard Goods	23, 60
Depillers	Liebersil / Lieberfoam	Sewing machines, tools	3 - 10	Z	
Dress Forms	Liebersew™	Sewing machine parts, oil, motors	10, 11	Zigzag machines	6
Dressmaker Ham	Light Bulbs	Sewing machine stand & motor	11	Zipper bags	29
Drill cloth	Lingerie guards	Sewing Tools	11, 17	Zipper feet	10
E	Linings	Sheldon, Boiler and Irons	55	Zipper tools	18
Easy Dry	Lint rollers	Shirt buttons, Shirt buttoner	32, 70	Zippers	42-46
Edge Guide / Gauge	Lint shavers & removers	Shoulder pads	24, 25	Zippers, parts	42-46
Elastic	Low Boy assembly	Silicone Foam Padding	60	Zipper Sliders, Stops	46
Elbow patches	M	Silicone Spray	65		
Electric Duster	Machine oil	Silk thread	50		
Everblum GOLD, Dry Spotter	Magic Sleever	Skins	50		
Everblum products	Magnetic Bobbin Holder, Pinholder	Skirt Clips, Pant	28		
E-Z Off Iron Cleaner	Magnets	Skirt Marker	21, 26		
	Magnifier	Sleeve boards, covers and pads	59		
	Make-A-Zipper, Rolls				



Our mission remains as always, to give our customers the best service. We consider it our obligation to offer our customers the best products that are available for the industry. We import the best equipment and always search for new items that will improve the efficiency and productivity of your business.

We are a family business and have enjoyed working for this industry for over seventy years and are looking forward to many more. We value our relationships with our customers and we welcome your phone calls with questions and inquiries and are always happy to share our knowledge with you.

Our inside sales staff here in Charlotte is familiar with every item in our catalog and many more that could not be included. They will suggest the appropriate product for you and acquaint you with ongoing sales and save you money every time you place an order with us. We value the personal contact with our customers.

You will benefit from our traveling sales force in many parts of the country. They will share many years of accumulated knowledge and experience with you. They will show you our newest products and bring a full sample line into your shop.

Our mechanic is knowledgeable on the varied sewing machines and pressing equipment we sell as well as the parts your repairs might require. He is a great asset to our business and for many years has answered your frequent questions to your satisfaction.



Our machines are “sewn off,” tested before we ship them to you.

We gladly answer your questions about irons and boilers and the service you can expect from this equipment from our in-house repair service.

Our prices are as low as possible. We offer you “Specials” at extra low prices whenever we can. Watch for our seasonal “Supersavers.”



HOW IT ALL BEGAN: THE STORY OF JERRY LIEBERMAN "THE BUTTON MAN"

Jerry Lieberman was eighteen when he served in World War II in France and Germany. He was an interrogator of captured German war prisoners. He was trained in Camp Ritchie Maryland, with other German speaking refugees. They were called Ritchie Boys for short.

After the war, Jerry Lieberman held a job while studying business at night at NYU. In 1949 his father suddenly died of a heart attack. Jerry now had to support his mother, Bella. His father left a small stock of buttons, which Jerry took and sold out of his Army surplus car.



He did well on the road and saw a future for himself and his mother. It was 1949 when he started B&G (Bella & Gerald) Lieberman Co. Then a refugee and friend of Jerry's, Walter Marx and his wife Lee entered the business and the rest is history.

MORE ABOUT US

We are proud to be an asset to our industry. Our attention to service and care of our customers and our relationships with our suppliers has been very evident in the great outpouring of memories and condolences after the death of Jerry Lieberman on Thanksgiving 2011.

TESTIMONIALS

We would like to share some testimonies that have been sent to us:

An email from a new telephone customer:

"I'd like to take the opportunity to thank you for the wonderful customer service that I received today from the gentleman in the parts department. Very helpful, polite, and curious. Like a breath of fresh air."

– Catherine Burns

"Larry has always provided prompt service for our needs at Best Cleaners, Mpl, St. Paul. A great company to do business with."

– Don L. Gray, Sr.

"A great bunch of people that are always helpful, polite and a joy to talk to."

– Adele Rossow Helleksen

"These are really good people."

– Jim Smith

"My relationship with B&G Lieberman is an interesting one. It spans over twenty years and has evolved from a client/supplier relationship to a genuine friendship. Early on we had our share of misunderstandings and Jerry Lieberman, being the benevolent person he was, always managed to resolve any conflict tactfully. He was a class act and a wonderful person, qualities that are mirrored in Larry. These qualities transcend throughout the company and to this day I have a great relationship with Larry and everyone at B&G Lieberman. They have been my primary supplier of buttons and all sewing notions, equipment and myriad other supplies. I look forward to continuing a valuable relationship with B&G Lieberman in the future."

Sent from my ipad –Cooki Patel, 2011 Cleaners

**** SOME OF OUR EXCLUSIVE PRODUCTS ****

COLD SPOTTING ADD-ON CONVERSION KIT

Use compressed air to prespot or post-spot any stain.
Post-spot without leaving a ring.
Fits most spotting boards.

COLD KIT installed on CISSELL Spotting Board



Page 61

EMSIG Super DURABLE Buttons - Page 30



The physical and chemical properties of the EMSIG Super-DURABLE buttons provide a product of superior impact resistance and compression strength. These buttons, formulated by chemical research and design by futuristic engineering, withstands the most number of washings without loss of strength, color and clarity. The method ASTM-517 developed by the ASTM.

GRAVITY FEED IRONS - Page 48



Gold Eagle DL1900 A

Heated Vacuum Pressing Table

Page 51

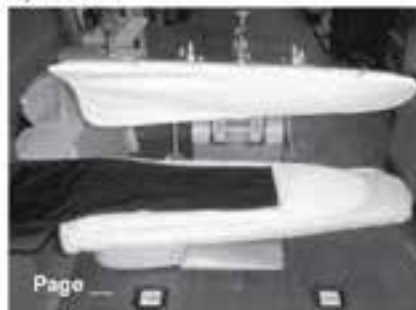

Page

the ingenious
"LIEBERLEGGER"
cloth lets the presser
press both pants legs at
once. Saves half the
pressing time. Does not
diminish quality finish.

B&G LIEBERMAN
 2420 DISTRIBUTION STREET
 CHARLOTTE, NORTH CAROLINA 28203

B&G LIEBERMAN

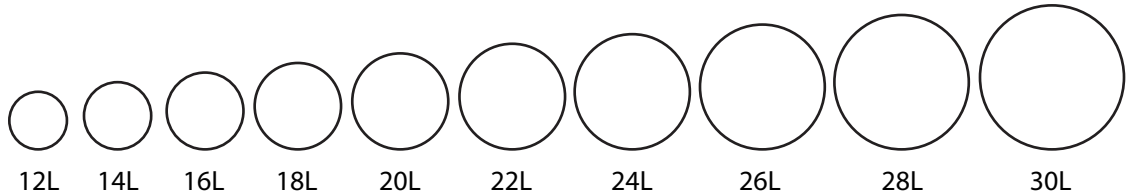

B&G LIEBERMAN CO INC • 2420 DISTRIBUTION STREET • CHARLOTTE, NORTH CAROLINA 28203 • (704) 376-0717 • TELEFAX (704) 333-1676 • TOLL FREE 1-800-438-0346 (NATIONAL) • www.bgliieberman.com

SUPER DURABLE

AVAILABLE IN 4 GROSS BOXES

JC PENNY Dark Smoke  14L 18L				EL GRECO Brown  14L 18L		Beige  14L 18L		Grey  14L 18L		<p>These buttons that are not shown in the catalog.</p> <p>To order call 704-376-0717 or 1-800-438-0346.</p> <p>Order online at www.bgliieberman.com</p>				WANDA Blue  18L		Horn  18L		Brown  3gr 20L	
JC PENNY Smoke  14L 16L 18L		White  14L 16L 18L		KNIGHT  14L 18L		LANDS END  13L 15L 27L		NEW LANDS END  13L 15L 20L						CHALK Black  3gr 20L					
Grey  19L		LANCE Black  19L		Cream  19L		Earth  19L		LEVI  14L 18L	LORENZO  14L 18L	CALVIN White  14L 16L 18L		CALVIN Baby Blue  18L		JKHAKI  14L 18L		KODIAK White  3gr 20L			
PEARL  14L 15L 17L 19L	PRINCE  13L 15L 17L	ROB  14L 18L	TAYLOR White  14L 16L 18L		Smoke  14L 16L 18L	TOMMY  13L 19L	TIN-TIN  14L 17L	ALEX  13L 15L 17L		ROYAL  27L		DULL BLACK  27L							
CEDAR DULL  14 18 20	CEDAR POLISH  14 18 20	CEDAR DARK  14L 18L 20L	APRILLE  14L 18L	WALDEN 308  14L 18L 20L	WALDEN 994  14L 18L 20L	WALDEN ROCKHORN  14L 16L 20L	WALDEN LONGHORN  14L 18L 20L	<p>See buttons in catalog pages 32-36.</p>											